

New England 4-H Horse Show Rules and Guidelines

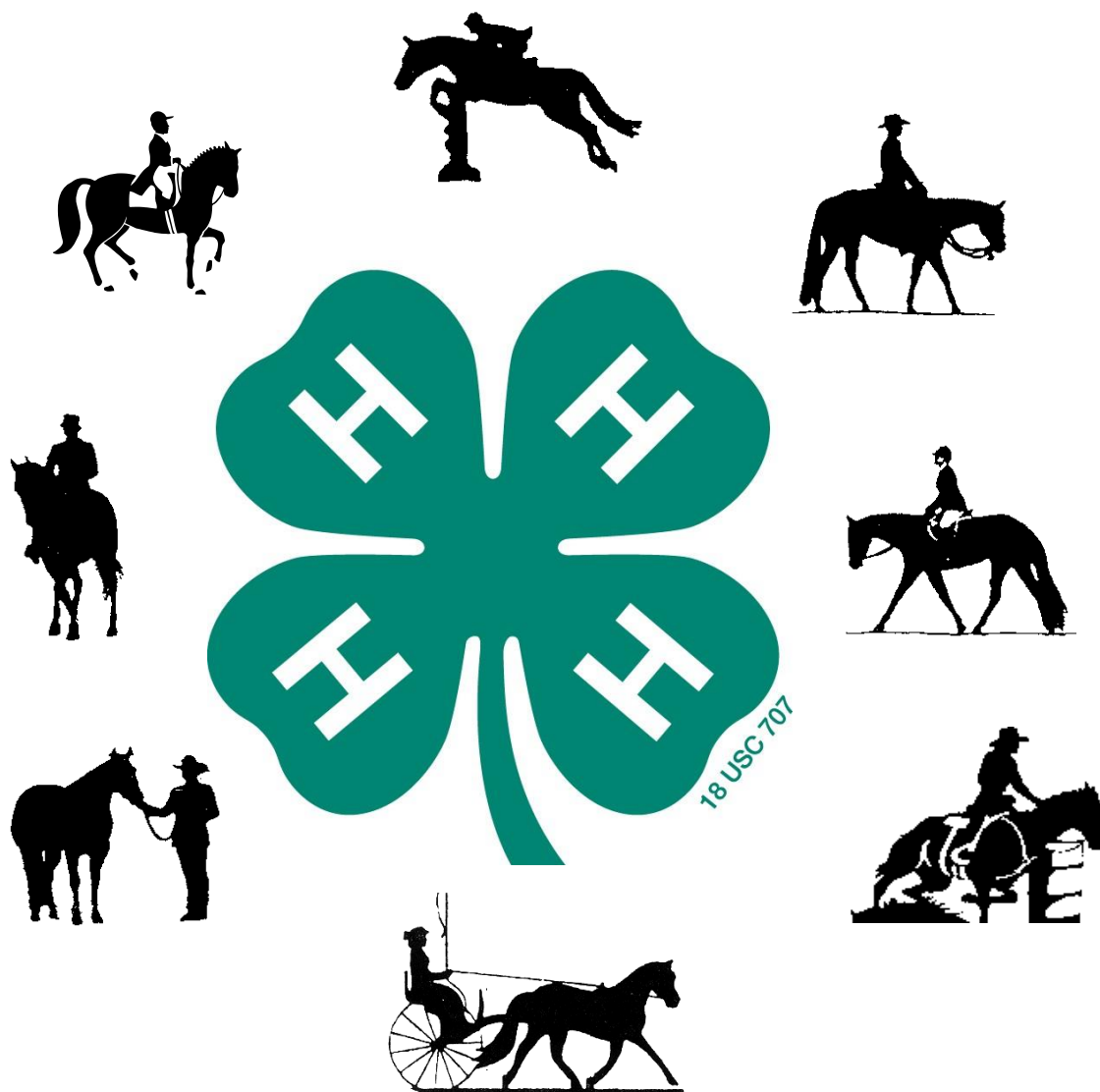

Basic guide to local, county, and state/regional 4-H Horse shows as well as for those classes in open shows limited to 4-H membership entry. This rules manual is for organizers, officials, exhibitors, parents and judges.

Revised January 2022

All revisions of the New England 4-H Horse Show Rules and Guidelines Book is recommended by the Judges School/Rulebook subcommittee and then voted on by the full voting members of the New England 4-H Horse Program Committee. Membership may be found with the New England Co-operative Extension/4-H Offices, contact your local county extension office.

If you are a person who will need an accommodation to participate please contact the event manager to discuss your needs. Requests for accommodations must be received 4 weeks prior to the event.

Be it known that all updates are marked and to the best of our ability all spelling and grammar has been corrected. This does not discount however that some instances of omission may have occurred. If you note any item you feel is incorrectly entered please contact the state 4-H person in your location and have them contact us via email so that we can make a note for the next round of editing for this rulebook which will be in 2024.

Items in regular print are rules that need to be followed in each state.

Items in italics are guidelines that may vary from state to state.

Original document prepared by:
Cheryl LeFebvre, Secretary
Robert Bartlett, Work study Student
University of Vermont
State 4-H Office

2006

Revisions 2009, 2010, 2011, 2013, 2014, 2016, 2018, 2020, 2022

<https://www.usef.org/compete/resources-forms/rules-regulations/rulebook>

<https://usdf.org/>

[Rulebook | US Equestrian \(usef.org\)](#) Tiles to choose division reference, ranch is under western division

<https://www.amha.org/>

<https://americanminiaturehorse.com/mini.htm>

<https://www.shetlandminiature.com/rulebook>

TABLE OF CONTENTS

Introduction	page 4
Objectives for New England 4-H Horse Shows	page 4
Use of Name and Emblem of 4-H	page 5
Judges	page 6
Show Personnel and Responsibilities	page 7
Eligibility of members and Animals for 4-H Horse Shows	page 10
General Rules	page 11
Disqualifications	page 12
Safety Precautions	page 13
Danish System/Ribbons	page 14
4-H Fitting and Showmanship	page 14
Side Saddle Division	page 18
Saddle Seat Division	page 18
Hunt Seat Division	page 19
Hunter Division	page 22
Jumper Division	page 24
Dressage Division	page 27
Western Division	page 28
Western Reining	page 34
Western Handiness	page 41
Ranch Division	page 44
Miscellaneous Classes	page 52
Driving Division	page 59
Small Equine Division	page 76
Liberty Division	page 84
Gymkhana Division	page 84

Introduction

These rules have been developed to serve as a basic guide for local, county, and state/regional 4-H horse shows as well as for those classes in open shows limited to 4-H membership entry. This manual is for organizers, officials, exhibitors, and parents. The purpose is to assure uniformity in organization, judging criteria and procedure throughout New England. There is no intent in the publication of these rules to suggest that all classes listed be held at any show, nor is any limitation implied of shows to only offer those classes listed. It is suggested that 4-H shows adopt these rules to govern the operation of these shows:

The 4-H Horse Show places the major emphasis on the accomplishments and development of the member. Because the economic background of 4-H members varies widely, the quality of the horse is not directly related to the member's abilities. Under saddle classes should be judged on manners, suitability, and performance with minimum emphasis on conformation.

First and foremost, all exhibitors will conduct themselves as young ladies and gentlemen. Politeness and good sportsmanship are expected. Any adult will be expected to conduct themselves in such a manner as to set a good example for the 4-H exhibitor and other spectators at the event.

When youth are assigned to the appropriate horse show class, and the youth with disabilities are appropriately supported, participating youth can compete on a level playing field.

All questions and concerns should be addressed with the event manager. The event manager will clarify with the steward if available using the most current editions of the NE 4-H, United States Equestrian Federation, United States Dressage Federation and American Miniature Horse Registry/American Shetland Pony Club/American Show Pony Registry

With publication of this manual it is assumed that all 4-H shows will be run in accordance with these rules and guidelines unless exceptions are noted in the class list.

Objectives for New England 4-H Horse Shows

Help 4-H Club Members

- To develop personal traits which will enable them to become more effective citizens and assume roles in leadership.
- To develop teamwork and sportsmanship.
- To become aware of opportunities within the horse industry.
- To learn and better understand new developments and methods in agriculture as related to the horse industry.
- To obtain wholesome competitive experience on a broader level above and beyond those available in the individual counties.
- To exhibit animals, they have cared for or worked with in project activities over an extended period.

Expectations of Ethics

It is understood that all exhibitors, parents, leaders, trainers, coaches, spectators or anyone else on the horse show grounds will adhere to the following expectations:

1. Be worthy of trust, honor and confidence.
2. Respect all people, including myself.
3. Be responsible, accountable and self-disciplined in the pursuit of excellence.
4. Be just, fair, and open.
5. Be caring in relationships with others.
6. Be aware that actions and decisions affect others and strive to be a contributing and law-abiding citizen.

Dress Code and Program Content Expectations

In 4-H, and in everything we do, we are role models for youth of all ages. Therefore, we have high expectations that 4-H members, leaders, and volunteers will abide by certain dress codes and program content expectations. Dress Code attire for individual classes will be addressed within the guidelines.

1. All clothing should be neat, clean, and appropriate for activity.
2. The entire torso must be covered.
3. Hair should be neatly combed and appropriately contained.
4. Any graphics, or printing on any clothing, which is considered obscene or offensive, is unacceptable.

Program Content/presentation – our participants and spectators at these activities include youth of all ages, therefore:

1. **Lyrics, costumes, signs, dialogue and other program content should support positive 4-H / youth developments. All music for the New England Show at ESE must be screened.**
2. Violence will not be promoted.
3. Sexually explicit material and foul language will not be included.
4. Content will not be degrading or offensive to any population.

Use of the Name and Emblem of 4-H

The use of the name and emblem of the 4-H is regulated by federal law. This law states that only activities or programs under supervision of Cooperative Extension may use the name and emblem of the 4-H club work. Any district, area, or state 4-H horse show must have approval of the State 4-H Office. Local, representative county, regional, and state 4-H Shows or events sponsored by other organizations or individuals and shows which do provide separate classes for 4-H members are not permitted to use the name and emblem of 4-H without approval of appropriate Extension offices.

The 4-H Show

A 4-H horse show **MUST** be conducted by a 4-H horse club or group of 4-H horse clubs, or member delegates from 4-H horse clubs/councils at the local, county, regional, or state levels.

- A. There are two types of 4-H Horse Shows
 1. The 4-H Horse Show:
 - a. Limited to 4-H members only.
 - b. May be divided into divisions.
 2. The 4-H Open Horse Show
 - a. Is open to the public.
 - b. Should offer 4-H divisions and classes.

- B. In a 4-H Horse show or a 4-H division at an Open Horse Show, Fitting and Showmanship classes must be offered.
- C. Any non 4-H affiliated show intending to offer 4-H classes must contact the state 4-H office and follow procedure as directed by that office.

Judges

1. Judges will be competent, well-qualified adult (18 years of age or older) individuals, whose names appear on any or all of the following lists: New England 4-H Horse Judges, other state 4-H Horse show judges lists, USEF judges list, New England Horseman's Council, local horse councils, breed judge's lists, or referrals from established horse show management.
2. A judge at all times should conduct themselves in an exemplary and professional manner showing courtesy and respect to show management, colleagues, exhibitors and spectators. Judges should also wear appropriate attire including no open toed footwear while judging a 4-H approved or sponsored show.
3. The judge must place each class in accordance with the rules and class specifications of this handbook, thus they should be knowledgeable of all allowable tack and equipment for appropriate classes.
4. The decision of the judge is final.
5. An exhibitor does not have the right to inspect judge's cards. However, an exhibitor may request of the show committee or steward the reason for the decision at a proper time and place. The show committee may request the judge to give his reasons. A judge is not to be approached with regard to any decision while judging or about to judge.
6. Any questions or concerns must be addressed to the event manager / show committee who may then approach the judge if necessary.
7. If judges are expected to judge more than one division, be sure they are qualified in each division. Judges shall be knowledgeable of breed distinctions and shall judge classes accordingly.
8. The use of different judges each year is encouraged. Any judge who is hired to judge at Eastern States Exposition will not judge any state's qualifying show in that same year.
9. Show management shall instruct judges that major emphasis of 4-H classes is placed on the exhibitor's accomplishments, not the quality of the horse.
10. Good judging depends upon the correct observance of horses and / or riders and the measuring of them against a standard commonly accepted as the ideal, according to the conditions of the class being judged. A judge serves three interests: his/her own conscience, the exhibitors, and the spectators. He/she should make clear to the audience that it is the best horse or riders in his/her opinion, who wins. If the judge is unclear about something, he/she should feel free to ask the child or show superintendent about the situation. 4-H club work is a learning experience, and the members should be able to follow the judging procedure.
11. A judge must adjudicate each class in conformity with the rules and specifications of the class as they appear in the rulebook.
12. The decision of the judge is based solely on his/her individual preference.

SHOW PERSONNEL AND THEIR RESPONSIBILITIES

Show Committee/Manager

1. The show committee will be responsible for the operation of the show. It will be the duty of this committee to enforce all rules as set forth in the rulebook. It is the responsibility of the show committee to notify the judge of any accommodation to established rules for that day's show.
2. The show committee will determine the requirements for any class that is not clearly defined in the manual and **post the course, in cases where necessary, at least one hour before the scheduled time of class.**
3. The show committee will eliminate, without waiting for protest to be made, any improper entrant of a horse or rider, after notifying entrant of error.
4. It is recommended that the show committee include in their show rules and conditions that proof of the exhibitor's age is required and must be available for inspection during the show. They must also insist that for a 4-H Show or a 4-H Class in an open show the exhibitor presents the HORSE APPROVAL FORM for the respective state.
5. The show committee has the right to select a steward. A steward should clearly understand that he has no connection with the show committee or personal involvement with the judging of the show. He/she should point out in a diplomatic manner any instances where the rules are not enforced. He/she should not dictate to the judges or the show committee, but should immediately report to the appropriate officials any violations of the rules, which might invalidate a class. He/she should keep him/herself available to judges, exhibitors, and the show committee.
6. Show committee shall at all times clarify the application of 4-H horse rules and investigate any situation where the rules are not upheld.
7. It is the responsibility of the show committee to provide a copy of this rulebook to the judge for his/her use two weeks prior to the event.
8. Show committees/judges are all responsible for noting any cases in which an entry poses a danger to other entrants. The judge may dismiss any entry that presents a risk to themselves or other entrants in the ring.

Secretary

Duties may include, but are not limited to:

1. Accepts entries, both before and during the show. (At ESE this falls to the show Superintendent)
2. Reviews entries for completeness and accuracy, paying particular attention to date of birth of exhibitor for youth classes, and making sure entry fulfills all show rules.
3. Accepts entry fees and other related income.
4. Posts entries to individual classes to determine number of exhibitors in each class.
5. Prepares announcer list.

6. Prepares judge's cards.
7. Calculates Championship points from results on judge's cards.
8. Oversees distribution of ribbons and/or trophies.
9. Collects and submits bills for payment.
10. Prepares and presents financial report to Show Committee (see Organizers Information).
11. Answers procedural questions.

Steward

1. May be the Show Committee or some other designated adult with previous experience and it is best that they be selected from the New England 4-H Judges and Stewards listing. Or from the USEF list.
 - a. Stewards must be familiar with the New England 4-H Horse Show Rule Book.
 - b. Stewards must be tactful yet assured enough to enforce the rules.
 - c. Stewards should be willing to take the time to educate.
2. The steward is responsible for verifying the enforcement of rules as set forth by the governing 4-H Horse Show Rule Book and the show committee.
3. The current USEF Rule Book shall govern absence of a specific rule.
4. The steward should remain available to the judge, exhibitors and show committee at all times to clarify the application of the rules.
5. The steward should investigate any situation when rules are not upheld.
6. The steward is the one to be approached with questions, not the judge.
7. Formal protest must be in writing, accompanied by a fee as determined by the show committee and filed with the secretary before the end of the show. Protest fees will be refunded only if protest is upheld. In the event protest is not upheld, protest fee reverts to the show treasury.

Ringmaster

1. The ringmaster is in the ring with the judge but is conscious not to block the judge's view of the competitors.
2. The ringmaster conveys the judge's directions to the announcer and competitors.
3. The ringmaster observes exhibitors and informs the judge if problems arise.
4. In the absence of a ribbon runner, ringmaster shall distribute ribbons and trophies in classes.

Announcer

Shall move the show forward by announcing:

1. General information and rules as necessary.
2. Class and exhibitor information.
3. "On deck" status for the next class.
4. Awards.
5. Next class entering the ring.
6. Shall be concise and shall not monopolize the airwaves.

Supervisors of Warm-up Area

1. MUST KEEP SAFETY ISSUES FOREMOST.
2. Must be an adult designated by the Show Committee.
3. Individuals not complying with the direction of the Warm-Up Supervisor will be reported to the Show Steward and may result in dismissal from the show.

Other Show Personnel

1. Gate people
2. Recorder
3. Timer
4. Ribbon Runner (good use of members not exhibiting)
5. Food Booth Staff (good use of members not exhibiting)

Emergency Personnel

(On location or on-Call)

1. Veterinarian
2. Farrier
3. EMT
4. Ambulance
5. Police and Fire

Rider/Age Divisions

(For 4-H purposes a rider's age is as of January 1st)

All ages for riders, handlers and participation are determined by each state with suggested ages and divisions listed

1. *Lead line - Person leading must be at least 14 years of age. Not to be judged, all exhibitors receive participation awards. Classes for those under 9 please check with your state/county office.*
2. *Beginner/walk trot - 18 years and under - have never cantered/loped in any competition or on the grounds thereof, exhibitors over 12 should be in their first or second year of riding. In Walk Trot when the animal performs more than 3 continuous strides of canter the rider will be penalized.*
3. *Advanced Beginner - 18 years and under - exhibitors may compete in Advanced Beginner one season or eight shows. Cantering/loping may be done briefly, individually, or in small groups.*
4. *Junior - 13 years and under*
5. *Senior - 14 years through 18 years*
6. *Adult - 19 years and older*

Eligibility of Members and Animals for 4-H Shows and Competitive Activities

1. *A member may carry more than one animal for his/her 4-H project. If this is the case, each animal must be listed on a HORSE APPROVAL FORM.*
2. *The member must present the 4-H Approval Form to the show secretary at each show before being allowed to participate in a 4-H horse show. It is mandatory to present this form for 4-H classes in open horse shows sponsored by organized horse clubs.*
3. *Exhibitor must show his/her own projects. Project animals may be owned by the 4-H member, leased, loaned or shared.*
4. **To exhibit an equine at the New England Regional 4-H Horse Program at Eastern States Exposition, the 4-H member must have cared for or worked with that project animal listed on their state's 4-H animal approval form on or before **May** 1 of the current year.**
5. *Any type of equine may be used for a 4-H Horse Project. The animal should suit the size, skill and competency of the youth. The youth should be able to keep the equine under control at all times and manage the equine safely. When in the ring if this is not possible, equine and youth may be excused from the ring by the judge.*
6. *A two-year-old horse cannot compete in any 4-H approved under saddle classes prior to May 20th of the current year.*

7. No youth exhibitor may show a stallion over one year of age.
8. The administration of any drug/herbal supplement to a horse shown in any 4-H class should be checked against the current USEF Guidelines for drugs and medications to see what is allowed and prohibited and then notify the 4-H Horse Show office with appropriate form for documentation. If the substance is on the banned or restricted medication dose list the 4-H participant must know they may not be allowed to show. This list may be found at:
<http://www.usef.org/documents/drugsMeds/DrugsMedsGuidelines2012.pdf>
9. Horses that naturally perform at a lateral gait as opposed to a diagonal gait will be judged accordingly (i.e., Tennessee Walking Horse).
10. *Animals that are known to kick must be marked by a red ribbon in the tail.*
11. **Pony and Horse classes shall be designated according to the following:**

Horse.....	Over 14.2 hands
Pony.....	14.2 hands and under
Small Equine.....	12 hands and under
Miniature Horse.....	39 inches and under (measured at the last hair of the mane)

GENERAL RULES

Use of unconventional equipment must be approved by the show steward and/or show committee prior to the start of a show. **No mechanical devices of any sort may be used during warm up or in practice ring.** Such devices may include, but are not limited to, tie-downs **(except for gaming)**, draw reins, **standing** martingales (except for exercise over fences) and action enhancing boots or shackles. Protective leg boots, bell boots and polo wraps may be used during exercise. Any other equipment in question must be legal in the show ring in order to be used in exercise. See the show steward or show management for questions.

1. Any treatment of a horse by anyone on the grounds, which may be considered cruel, abusive or unnecessary, is prohibited. The show committee/ steward may disqualify anyone mistreating an animal and ask him or her to leave the grounds. An official report may be filed with appropriate authorities.
2. All participants in any 4-H shows/activities are required to wear a properly fitted ASTM/SEI **equestrian helmet** with secured chin harness properly fastened while riding or driving in designated schooling areas, the show ring, and while riding or driving anywhere on the competition grounds. This applies to all 4-H exhibitors. This also applies to **open** exhibitors under 18 years of age participating in a 4-H Horse Show. **THERE WILL BE NO PENALTY AT SHOWS FOR PARTICIPANTS WEARING A PROTECTIVE EQUESTRIAN HELMET IN ANY CLASS.**
3. 4-H CLASSES ARE RESTRICTED TO ENROLLED 4-H MEMBERS ONLY with their approved project animals.
 4. The decision of the judge is final.
 5. Classes may be cancelled, combined or divided at the discretion of the show committee.

6. All patterns will be posted at least 1 hour prior to the class. Pattern deviance may be cause for score penalty up to and including disqualification. **If in question, patterns should be performed as written, not as drawn.**
7. Judges may not ask exhibitor to switch horses in under saddle classes.
8. Every 4-H exhibitor, if they are under the age of 18, must have an adult on the grounds that will assume responsibility for him/her.
9. Horses are not allowed to be kept in or tied to trailers that are not attached to tow vehicles.
10. 4-H exhibitors are to prepare and manage their own project animals to the extent of their ability. In regard to safety justifying assistance, that intervention will be at the discretion of the participant's parent or designee (in writing) or themselves if they have attained majority. Exception to the above wording would be any ESE participant who must be able to manage their horse in all state and regional phases of ESE selection and competition.
11. Tack changes or holds should not be longer than three minutes. Time begins when the last horse in the previous class leaves the ring.
12. Any changes in the show schedule should be announced in the timeliest fashion possible.
13. **Animals must be serviceably sound and healthy, or they will be excused from the ring.** Soundness of each horse is at the discretion of the judge. Obvious lameness shall be cause for disqualification. Obvious lameness is consistently observably at a trot/**alternate gait** under all circumstances; marked nodding; hitching or shortened stride; minimal weight bearing in motion and/or at rest; and inability to move.

14. **Disqualifications:**

At the judge's discretion, an exhibitor **MAY** be disqualified for any of the following reasons:

- Broken or malfunction of equipment
- Evidence of poor sportsmanship on the part of the rider.
- Use of prohibited tack or equipment after the class is called to order.
- Lack of sufficient control of the horse by its rider.
- Lack of appropriate forward motion at any gait.

At the judge's discretion, an exhibitor **WILL** be disqualified for any of the following reasons:

- **A horse deemed out of control or unmanageable by a judge will be disqualified from the event and the entire show with no refund of entry fee**
- Fall of horse and or exhibitor in any class will eliminate placement.
- 1. A **rider** is considered to have fallen when they are separated from their mount in such a way as to necessitate remounting or vaulting into the saddle.
- 2. An **exhibitor** is considered to have fallen when they are unexpectedly separated from the animal, they are handling that constitutes their inability to safely handle the animal in the class. Exception will be in the small equine hunter and jumper classes; this is specifically designated in the small equine division.
- 3. A **horse** is considered to have fallen when the shoulder and haunch on the same side are touching the ground or an obstacle and ground.
- Failure to complete designated pattern or being on the incorrect side of designated marker
- Any treatment of the horse by its exhibitor which the judge deems to be cruel, abusive, and unnecessary treatment.

Safety Precautions

1. Helmets required, see #2 above. In the interest of safety, there will be no penalty at 4-H Horse Shows for exhibitors wearing protective headgear in lieu of traditional hats.
2. Horses should be confined to warm-up areas and prohibited from spectator and food areas.
3. Horses should be kept at a walk except in the warm-up area and show rings.
4. Exhibitors are responsible for having their equipment in good repair.
5. Ring gates should be kept closed during all classes and competitions.
6. It is recommended that plastic or rubber cones be used for markers in reining patterns.
7. **Dogs should be quiet and kept on a leash in hand. If show management deems any dog to be a show hazard, they will ask the owner to remove the dog immediately and if they are unwilling, they will be asked to leave the show grounds. Service dogs are allowed. Please note this will pertain to other pets that may attend horse shows.**
8. **Parents must be in direct physical control of small children at all times.**
9. Poles and other obstacles should be made of a safe material.
10. Limit the size of classes for safety (suggested maximum of 20). Consider size of ring and ability of riders.
11. Youth with documented disabilities will not be penalized for reasonable accommodations requested to perform in a 4-H class. Youth with documented disabilities may receive accommodations in the form of modified testing. **Note: show management must receive reasonable accommodation request 4 weeks in advance of event date. Show management can best plan for reasonable accommodations by receiving notice 4 weeks in advance of event date.**
12. Tongue tying is allowed per breed standard.
13. Ear plugs will be allowed per breed and discipline.
14. Bitless bridles for mounted equines are not allowed but may be considered with a veterinarian certificate which includes diagnosis for use when said documentation is submitted 4 weeks prior to the show.

Health Precautions for Horse Shows and Events

Show committees or management may require a health statement from a veterinarian stating that the animal is sound and free from communicable diseases, to be presented upon registration at a show or event. All equines (with the exception of MA at the time of this revision) must be vaccinated for rabies and a verification of this must accompany the animal to all events. A negative Coggins test **MUST** accompany all horses dated appropriate to locale of show. It is recommended that all horses be properly immunized.

Please check with show committee for required health documentation.

Danish Awards System

Danish Awards system description of scoring.

Using the Danish System, all exhibitors receive ribbons. Ribbons will be awarded according to the total scores from the judge's card.

For Fitting and Showmanship using the Uniform Scorecard:

One Judge Scoring

Blue = 90-100

Red = 80-89

White = 0-79

Two Judge Scoring (2 stations)

Blue = 85-100

Red = 70-84

White = 0-69

Times for Danish placing in games:

Keyhole Race Times for 4-H Ribbons

Blue	Red	White
8-16	17-25	26 and above

Barrel Race Times for 4-H Ribbons

Blue	Red	White
8-26	27-34	35 and over

Pole Bending Race Times for 4-H Ribbons

Blue	Red	White
24-32	33-41	42 and above

Ribbon Awards-American System

1st: Blue

2nd: Red

3rd: Yellow

4th: White

5th: Pink

6th: Green

7th: Purple

8th: Brown

9th: Grey

10th: Light Blue

4-H Fitting & Showmanship

The purpose of the 4-H Horse Fitting and Showmanship program is to encourage 4-H'ers to maintain high standards of horse management and responsibility toward 4-H projects. A fit horse reflects continuous care and is not accomplished overnight.

GENERAL RULES

1. In accordance with your state 4-H office guidelines, exhibitor must be a currently enrolled 4-H horse project member with Horse Project Approval Form on file in the 4-H Extension Office.
2. All members should prepare their own project animal to the extent of their ability.
3. In 4-H Fitting and Showmanship classes, it is the exhibitors' efforts which are judged, NOT the breed type or conformation of the horse.
4. All 4-H Fitting and Showmanship classes must be judged according to the Summary of Uniform Scorecard Fitting and Showmanship contests.
5. There are two different forms of Fitting and Showmanship classes which can be offered:
 - a. Traditional, with one judge
 1. Traditional: One judge who judges both the fitting and the showmanship portions of the class.
 - b. Station, with two judges.
 2. Station: The **Showmanship Judge** scores the showmanship aspect of the entry. The **Fitting Judge** scores the appearance of the exhibitor and items listed under appearance of animal.

SUMMARY OF UNIFORM SCORECARD FOR 4-H HORSE SHOW FITTING AND SHOWMANSHIP CONTEST

APPEARANCE OF ANIMAL

Total Points..... 40

1. Condition (15 Points)

- a. The animal should be useably sound, have sufficient flesh, a smooth coat, and firm muscles.

2. Grooming (15 Points)

- a. Coat should be clean and free of stains. Hairdressing, hoof preparation and powder, if used, should be neatly and sparingly applied.
- b. Mane and tail should be clean and free of tangles and dandruff.
- c. Hooves should be trimmed and shaped. If shod, shoes must fit and not show undue wear. Clinches should be smooth. Hoof preparation is permitted, but not required.

3. Trimming, Braiding, and Banding (5 Points)

- a. The head should be made as attractive as possible by trimming excess or long hairs with special emphasis under the jaw and in the "bridle path" area. Trim and clip according to breed standard. The interior of the ears and tactile hairs may be clipped, but no penalty shall result from unclipped tactile hairs or ears provided excess or protruding hairs have been removed. Clipped areas will appear smoother if trimming is done 3-4 days prior to a show.
- b. Braiding or banding, if used, should be neat and suitable for breed and or discipline of horse. Miniature horses and ranch horses should not be braided or banded.

4. Tack (5 Points)

- a. Weanlings and yearlings must be shown in a halter to protect the mouth for future biting.
- b. Miniature horses are shown in a halter. Stock type halter preferred.
- c. All English horses shall be shown in a bridle appropriate to their discipline. There should be only one rein used on the bridle, i.e. when showing in a Pelham use only the lower or curb rein or use one rein by means of a converter and when showing in a full bridle use only the curb bit and rein and remove the snaffle bit and rein.
- d. Western horses to be shown in a halter, NOT rope type.
- e. Driving horses to be shown in - halter or bridle appropriate for their breed, English Snaffle bridle, Double Bridle with curb bit only, or plain leather halter. Driving bridle is not suitable for showmanship.

APPEARANCE OF EXHIBITOR

Total Points..... 10

- 1. Exhibitor shall present a neat and clean appearance and be attired in clothes appropriate to their discipline. Boots with heels are required. Spurs not allowed.
- 2. Exhibitors can choose to wear appropriate clothing should they choose to pick a seat to represent. Exhibitors showing small equines must wear a long-sleeved shirt, boots, and helmet or headwear.
- 3. Drivers are prohibited from wearing aprons in showmanship
- 4. Gum chewing will be penalized.

SHOWING ANIMAL IN THE RING

Total Points.....50

1. Leading (15 Points)

- a. The exhibitor must lead on the horse’s left side holding the lead shank (western) or reins (English) in the right hand 4-12 inches from the halter or bridle, with the tail of the lead/reins loosely in the left hand in a safe manner. It is preferable that the exhibitor’s hand not be on the snap or chain portion of the lead/bit continuously. The excess lead or reins should never be tightly coiled, rolled or folded. When leading, the exhibitor should be positioned between the eye and the mid-point of the horse’s neck, referred to as the leading position.
- b. Leading, backing, turning and initiating the set-up should be performed from the left side of the horse. The exhibitor should perform the work accurately, precisely, smoothly and with a reasonable amount of speed. However, accuracy and precision should not be sacrificed for speed. This should be with the animal’s head carried at a height appropriate to the type or use of horse. At no time should the exhibitor stand directly in front of the horse. (Small equines are the exception.)
- c. The position of the exhibitor when executing a turn is the same as the leading position, except that the exhibitor should turn and face toward the horse’s head and have the horse move away from them to the right. When making a turn, the horse should be turned to the right with the exhibitor walking around the horse. The ideal turn consists of the horse pivoting on the right hind leg while stepping across and in front of the right front leg with the left front leg. An exhibitor should not be penalized if their horse performs a pivot on the left hind leg, but an exhibitor whose horse performs the pivot correctly should receive more credits. When turning the horse to the left 90 degrees or less, turning to the left is acceptable.
- d. When executing a back, the exhibitor should turn from the leading position to face toward the rear of the horse with the right hand extended across the exhibitor’s chest and walk forward beside the horse with the horse moving backward.
- e. Exhibitors must never crowd other exhibitors. When behind another animal, exhibitors must maintain a horse’s length apart (8-10 feet). When lined up side by side, exhibitors must allow a safe distance between animals.
- f. When changing position in line:
 - 1. Exhibitors must lead the animal straightforward far enough so as not to disturb the horse on either side of them before making a turn.
 - 2. Exhibitors must return to the line by moving around the end of the line and leading forward either to their original position or to the place directed by the judge.
 - 3. Exhibitors must avoid leading their animal between the judge and the animal he is observing. Exhibitors must never stand between horse and judge.
- f. Using the Quarter System, the exhibitor is expected to move from side to side as the judge moves about in front, back, and alongside of the horse, always giving the judge an unrestricted view. The judge and exhibitor must always be in adjoining quarters (see below).

<u>Judge is in</u>	<u>Exhibitor should be in</u>
1	4
2	1
3	4
4	1

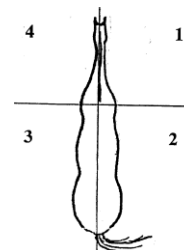

2. Posing (15 Points)

- a. When posing their animal, exhibitors must stand toward the front facing the horse, but always in relation to the position of the judge, in a position that is safe for themselves and the judge. The position of the exhibitor should not obstruct the judge's view of the horse and should allow the exhibitor to maintain awareness of the judge's position at all times.
- b. When setting the horse up for inspection, the exhibitor should stand angled toward the horse in a position between the horse's eye and muzzle and should never leave the head of the horse. When moving around the horse, the exhibitor would change sides in front of the horse with minimal steps and should assume the same position on the right side of the horse that they had on the left side.
- c. The horse is posed according to type and use (i.e., the American saddle horse) in the show, posing with feet slightly spread and head up, and the Hunter with the head in a natural position, feet squared, but one hind foot may be slightly in advance of the other.
- d. When posed, exhibitors must try to keep their animal still. They may support their horse with their hand on his opposite shoulder when the judge picks up a foot or attempts to push him off balance. Exhibitors must always regain their position quickly and without fuss.
- e. When the judge is observing other animals, exhibitors should stand quietly if posed reasonably well.
- f. The exhibitor should not touch the horse with their hands or feet, or visibly cue the horse by pointing their feet at the horse during the set-up. Exhibitors must do most of the showing with the reins or lead strap, never kicking their horses' legs into position.
- g. When working individually, exhibitors should pose the animal to the judge's directions. Never stand between your horse and the judge. The judge should have an unobstructed view of the animal.
- h. Exhibitors must show their animal at all times, not themselves. Over showing, undue fussing and maneuvering are objectionable.

3. Showing Animal to Best Advantage (10 Points)

- a. Exhibitors must quickly recognize any conformation faults of the animal they are showing and show it to overcome these faults.

4. Poise, Alertness and Attitude (10 Points)

- a. Exhibitors must keep an eye on their animal and be aware of the position of the judge at all times. They must not be distracted by persons and things outside of the ring.
- b. Exhibitors must respond rapidly to all requests from the judge and officials.
- c. Exhibitors must be courteous and sportsmanlike at all times. Exhibitors should stand and move in a straight, natural and upright manner and avoid excessive, unnatural or animated body positions.
- d. Exhibitors must keep showing until the entire class has been judged or excused.

ENGLISH DIVISIONS

SIDE SADDLE DIVISION

Appointments

Side Saddle shall be permitted in any class. ASTM/SEI helmets required. Saddle and bridle must be for the same seat ridden. Clothing and appointments should be neat, clean and appropriate for the seat ridden for the show ring. See the International Side-Saddle Organization for specific regulations.

Tack/Equipment

Appropriate sidesaddles must be used for English classes. All other tack will be specified in class rules.

All tack should be in clean, safe, serviceable condition for the horse and the rider.

General Sidesaddle

Sidesaddle riders will be permitted in all classes. They will be subject to all class rules and requirements.

SADDLE SEAT DIVISION

Appointments

Conservative, well-coordinated, well-fitted clothing is preferred; they must be neat and clean. Special clothing is not to be given preference.

1. **Minimum:** Saddle seat pants, Jodhpur boots, shirt, tie, vest, derby, soft hat or helmet for showmanship, ASTM-SEI helmet for mounted classes
2. **Preferred:** Saddle suit, jacket, gloves, and whip (no longer than 42 inches)
3. **Optional:** spurs of unroweled type, with a strap

Tack/Equipment

1. All tack should be in clean, safe, serviceable condition for the horse and the rider.
2. Flat English type saddle – i.e.: Lane Fox or cutback with leather lining preferred. Forward Seat or dressage type saddles with knee rolls are prohibited.
3. Entries will be shown in full bridles, although Pelhams are accepted.
4. Not Allowed: Martingales or similar tie-downs, any type of curb strap or chain not permitted by USEF, any artificial appliances, “gingered” tails, wired ears, bandages, boots of any type, and ankle chains.
5. Not to affect judge’s decision: Extended feet, weighted shoes, set tail.

SADDLE SEAT EQUITATION

Class Routine

Recommended to be shown both ways of the ring in appropriate gaits including but not limited to: walk, trot, extended trot, canter, hand gallop, reverse. Riders may be required to execute any appropriate pattern as requested by the judge. Appropriate patterns will be provided either by the show committee or the judge at the discretion of the show committee which they feel are appropriate to the caliber of the class. Patterns chosen shall be required of all riders selected for this additional performance.

Judging/Scoring

Emphasis in this class will be placed on the rider’s ability to effectively control his/her horse and maintain his/her basic position while doing so. To be judged 90% on the rider’s positions, use of aids and cues, and control of horse and 10% on personal appointments and tack. The

scoring of personal appointments and tack will be based on neatness of clothing rather than newness or expense, and cleanliness, condition and adjustment of tack.

Judged on seat, hands, and suitability of horse to the rider and the performance of the horse as it reflects the riding skill of the exhibitor. Patterns may be used to clarify this for judges and are not to compose more than 40% of total score.

Disqualifications: See # 14 under General Rules

SADDLE SEAT PLEASURE

Class Routine

Recommended to be shown both ways of the ring at the walk, trot, extended trot, walk, canter, walk, reverse and repeat on a reasonably loose rein without loss of contact. Horses will be asked to extend the trot. Entries may be asked to back in line up only. The horse should not back with excessive speed.

Judging/Scoring

Class to be judged on manners, performance and suitability of the horse as a pleasure mount. The smoothness, obedience and consistency of the performance will be considered rather than brilliance and animation.

Disqualifications: See # 14 under General Rules

SADDLE SEAT PERFORMANCE

Class Routine

1. Horses are to be shown at a walk, trot and canter both ways of the ring. The horse should display brilliance and animation appropriate for their breed along with proficiency in executing the required gaits. Horses should stand quietly and back readily.
2. All horses will enter the ring in a counterclockwise direction until otherwise directed by the judge. Recommended to be shown both ways of the ring at the walk, trot, extended trot, walk, canter, walk, reverse and repeat.
3. All horses will be brought to a flat-footed walk before changing gaits.
4. The judge may ask for additional rail work from any of the entries.

Judging/Scoring

Emphasis will be placed on the horse's suitability as a Saddle Seat performance type horse appropriate to their breed. Scoring will be based on performance and manners.

Disqualifications: See # 14 under General Rules

HUNT SEAT DIVISION

Braiding is traditional, but not required

All jump heights are at the discretion of the show committee

Appointments

Minimum

1. Appropriate heeled boots (hunt or jodhpur)
2. Breeches or jodhpurs
3. Shirt
4. ASTM/SEI Helmet

Preferred

1. Hunt Coat of conservative color
2. Choker or tie
3. Gloves

Optional:

1. Spurs of unroweled type, with a strap
2. Crops (maximum length 30 inches)
3. Traditional colored half chaps with matching paddock boots are acceptable
4. Any protective safety equipment for the rider (protective vest, other)

Tack/Equipment

1. Saddles of hunt or balance type preferred.
2. Regulation snaffles recommended or Pelhams with Cavesson nosebands and flat curb chain or straps. Kimberwicks and Uxeter bits are allowed. If a full bridle (curb and bridoon) is used, the bridoon is thicker than in an English Pleasure full bridle. Excessive length (greater than 4 inches from the bottom of the mouthpiece) of the curb shank shall be penalized. A judge, at his/her own discretion, may penalize horses with non-conventional types of bits and nosebands.
3. Standing Martingales are optional in Equitation Over Fences; they are prohibited in Hunter Hack and all flat classes. Any change of equipment during a class may be penalized at the discretion of the judge. Dropped, flash or figure eight nosebands are not permitted in any class under the hunt seat division.
4. Running martingales for jumper division classes only.
5. Boots and bandages may be worn in Equitation Over Fences only.

HUNT SEAT EQUITATION

Class Routine

Recommended to be shown both ways of the ring in appropriate gaits including but not limited to: walk, trot, extended trot, canter, hand gallop, reverse. Riders may be required to execute any appropriate pattern as requested by the judge. Appropriate patterns will be provided either by the show committee or the judge at the discretion of the show committee which they feel are appropriate to the caliber of the class. Patterns chosen shall be required of all riders selected for this additional performance.

Judging/Scoring

Class to be judged on seat, hands, suitability of horse to rider, and the performance of the horse as it reflects the riding skill of the exhibitor. To be judged 90% on the rider's position, use of aids and cues, and control of the horse, and 10% on personal appointments and tack. The scoring of personal appointments and tack will be based on neatness of clothing rather than newness or expense, and cleanliness, condition and adjustment of tack.

Disqualifications: See # 14 under General Rules

HUNT SEAT PLEASURE

Class Routine

All horses will enter the ring in a counterclockwise direction until the judge otherwise directs them. They are to be shown at the walk, trot and canter both ways of the ring. Horses may be asked to back. The pleasure horse should be easy to handle, obedient, and consistent.

1. After all, entered have been worked, the judge may then excuse contestants not to be further considered in the class.
2. The judge may ask for additional rail work from remaining entries.

Judging/Scoring

To be judged on the suitability of the horse as a pleasure mount, manners and performance. The smoothness, obedience and consistency of the performance will be considered rather than the brilliance and animation.

Disqualifications: See # 14 under General Rules

HUNTER UNDER SADDLE

Class Routine

All contestants will enter the ring in a counterclockwise direction until the judge otherwise directs them. Horses are to be shown at walk, trot, canter both ways of the ring and may be asked to hand gallop. Class may be split to hand gallop. May be asked to back. The judge may ask for extended trot. The Hunter Under Saddle should be obedient, alert, responsive, and move freely with a ground-covering gait.

- a. After all horses have worked, the judge may then dismiss any horse not to be further considered in this class.
- b. The judge may continue to work the remaining horses.
- c. At the hand gallop, the judge may ask the group to halt and stand on a loose rein.

Judging/Scoring

To be judged on the suitability of the horse for this style of riding, manners, control, and smoothness of the performance on the flat.

Disqualifications: See # 14 under General Rules

HUNT SEAT EQUITATION OVER FENCES

Tack/Equipment

Same as that for Hunt Seat Equitation except that the use of standing martingales is allowed. Dropped nosebands and running martingales may not be used.

Class Routine

The rider should demonstrate his/her ability in controlling the horse while going over fences such that a balanced, even pace is maintained while also maintaining a safe and suitable position.

1. The class will be held over at least six reasonable jumps.
2. The performance begins when the horse enters the ring or is given the signal to proceed after entering the ring. Except for refusals, jumping faults of the horse are not to be considered unless it is the result of the rider's ability.
3. Ticks and rails down shall not be scored in an equitation class over fences unless it is the fault of bad horsemanship. However, failure to complete a specified course or jumping fences in the wrong order shall be scored as "off course and the rider shall be eliminated".
4. Any or all contestants may be called back to perform a walk, trot, canter or execute any appropriate test of skill included in class requirements for Hunt Seat Equitation, or any of the following:
 - a. Jump low fences at trot.
 - b. Pull up between fences at trot, except in a combination.
 - c. Jump fences on a figure eight course.
 - d. Jump Serpentine course, showing change of lead.

In-Gate Diagram

Circling in either an Equitation Class Over Fences or a Performance Class Over Fences: Only one circle is allowed before fence #1. The size of the circle depends on the length and width of the ring. However, a circle of 100 feet diameter is the maximum allowed with fence #1 included in its circumference (see diagram). The circle may commence at a sitting or posting trot (correct diagonal) with a transition to a canter at least 5 strides before fence #1. Thereafter, a canter (unless the judge specifies otherwise) **MUST** be maintained. Once the exhibitor has commenced a circle, it must be continued. Incorrect, misshapen circles or failure to maintain a specified gait shall be scored as a refusal.

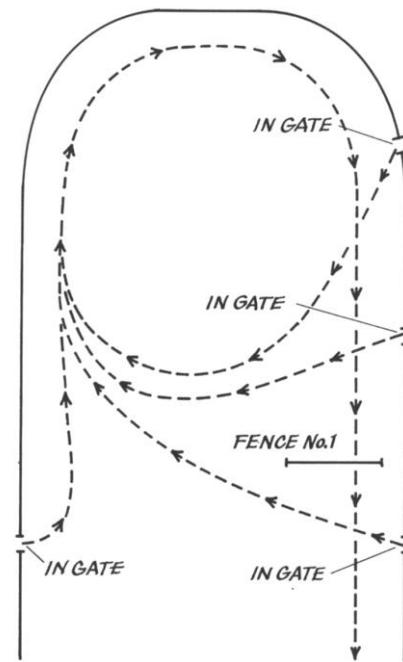

Judging/Scoring

Class to be judged on seat, hands, suitability of horse to rider, and the performance of the horse as it reflects the riding skill of the exhibitor. To be judged 90% on the rider's position, use of aids and cues, and control of the horse, over the course of jumps and 10% on the horse's ability in executing the course under the rider as well as #3 & #4 in the class routine. All tack will be as described in Hunt Seat appointments.

Disqualifications: See # 14 under General Rules

HUNTER DIVISION

Class Routine

The hunter should provide his rider with a safe, consistent ride at a working pace over a course of fences similar to those that might be encountered in the field. This requires that all horses must be serviceably sound and any horse showing evidence of lameness, broken wind or impairment of vision will be refused an award and will be excused from the ring by the steward, show veterinarian, or judge.

Each horse will individually negotiate a course consisting of at least 8 jumps over a minimum of 4 different obstacles. At least one change of direction is recommended. The course diagram must be posted at least 1 hour before the class is called. The course must meet the approval of the judge.

Jumps and Obstacles

1. Jump rails shall be at least 10' in width and wings can be up to 22" wide. They should have a substantial appearance. Rails shall be at least 3" in diameter. **Height will be a maximum of 2' 6" for horses and 2' 3" for ponies.**
2. A variety of natural obstacles are encouraged – using coops, gate, brush, jump, logs etc. Frightening, dangerous or strange jumps are to be avoided.
3. Combinations or in and outs are prohibited in Hunter Over Fences Classes.

Judging/Scoring

1. When a horse makes two faults at one obstacle, only the major fault will be counted, except refusals, which will count in addition.
2. When an obstacle is composed of several elements in the same vertical plane, a fault at the top element is the only one penalized.
3. Judges shall penalize unsafe jumping and bad form over fences, whether touched or untouched.
4. Circling once before beginning and after ending the course is permissible (see diagram).
5. Loss of forward motion will be scored as a refusal.
6. Major faults
 - a. Knock down
 - b. Refusal
 - c. run out
 - d. bolting on course
7. Elimination:
 - e. Extra circle
 - f. 3rd refusal
 - g. Jumping an obstacle before it is reset
 - h. Jumping an obstacle not included in course
 - i. Failure to keep proper course
 - j. Fall of horse and or rider in any class. A rider is considered to have fallen when they are separated from their mount in such a way as to necessitate remounting or vaulting into the saddle. A horse is considered to have fallen when the shoulder and haunch on the same side are touching the ground or an obstacle and ground.

Disqualifications: See # 14 under General Rules

HUNTER OVER FENCES

1. After completing the course, no horse will be requested to re-jump the course.
2. Upon completion of the entire class over fences, the finalists may be asked to jog their horses past the judge to show soundness.
2. The judge will penalize unsafe jumping and bad form over fences, whether touched or untouched.
3. Fences should simulate obstacles which might be found in the hunting field, such as natural post and rail, brush, stonewall, gates, chicken coops, Aiken or hedge. Spreads over 4 feet are prohibited. The use of unusual objects not likely to be found under ordinary hunting conditions should be avoided.

Class Routine

The hunter should provide his rider with a safe, consistent ride at a working pace over a course of fences similar to those that might be encountered in the field. This requires that all horses must be serviceably sound and any horse showing evidence of lameness, broken wind or impairment of vision will be refused an award and will be excused from the ring by the steward, show veterinarian, or judge.

Each horse will individually negotiate a course consisting of at least 8 jumps over a minimum of 4 different obstacles. At least one change of direction is recommended. The course must meet the approval of the judge.

Judging/Scoring

To be judged on performance, manners and soundness with emphasis on performance and manners. The scoring of performance will be based on the maintenance of an even hunting pace, manners, jumping style and way of moving over the course. Although faults are taken into consideration, final placing will not rely solely on this.

Disqualifications: See # 14 under General Rules

HUNTER HACK

Any change of equipment during a class may be penalized at the discretion of the judge. Dropped, flash or figure eight nosebands are not permitted in any class under the hunt seat division.

Class Routine

Horses are to be shown at a walk, trot, canter, and a hand gallop both ways of the ring. The judge may ask for extended trot. All horses are required to jump two fences. It is recommended that these fences be no more than two feet six inches in height. The horse should be similar to the Hunter Under Saddle in that he is obedient, alert, and responsive and moves freely with a ground-covering gait. His style of jumping should be smooth and consistent; such that he could be relied on to take his rider over fences in a safe, obedient manner at an even hunting pace.

1. All contestants will enter the ring in a counterclockwise direction until otherwise directed by the judge. All exhibitors will be asked to hand gallop. Class may be divided to hand gallop.
2. After all horses have been worked as specified in number 1; the judge may then dismiss any horse not being further considered in the class.
3. The judge may continue to work the remaining horses.
4. After the hand gallop, the judge may ask the group to halt and stand on a free rein.
5. The judge may ask any rider to back his horse in a straight line.
6. After horses have been worked on the flat, the judge will ask all horses to jump two fences each, no more than two feet six inches in height.

Judging/Scoring

To be judged on performance, manners and soundness with emphasis on performance and manners. The scoring of performance will be based on the maintenance of an even hunting pace, manners, jumping style and way of moving over the course. Although faults are taken into consideration, final placing will not rely solely on this. Scored 70% over fences and 30% on the flat.

Disqualifications: See # 14 under General Rules

JUMPER DIVISION

Appointments

Minimum:

1. Suitable shirt and hunt jacket or polo shirt. No sleeveless or collarless shirts.
2. Breeches or jodhpurs
3. Boot with a heel.

Optional:

1. Half chaps
2. Spurs are optional
3. Crops or bats (maximum length 30 inches)
4. Any protective safety equipment for the rider (protective vest, other)

Tack/ Equipment

Hunt type saddle, hunt type bridle with standard, drop, figure 8, or flash cavesson/noseband. Hackamores are permitted. Breastplates and cruppers are optional. Standing or running martingales are permitted. Bandages and/ or boots on horse's legs are permitted. See USEF rulebook jumper division for further equipment allowances.

Disqualifications

- Stirrup leather or stirrup or foot tied and/or secured in any manner
- Unsoundness of horse
- Three refusals
- Jumping an obstacle before it is reset
- Bolting from ring
- Off course
- Fall of horse or rider
- Failure to start on course within 45 seconds of judge's signal to proceed
- Starting on course before judge's signal to proceed
- Dangerous behavior or lack of sufficient control of the horse by rider
- Poor sportsmanship

Judging/ Scoring

Jumper classes are scored objectively, based entirely on a numerical score. Turnout is NOT to be considered. Placing is determined by the fastest time with lowest number of faults over a posted course of jumps. Jumping penalties are assessed for refusals and knockdowns, with each refusal or knockdown adding four faults to a competitor's score. Penalties for knockdowns are imposed only when the knockdown changes the height or width of the jump. If a horse or rider knocks down a bottom or middle rail while still clearing the height of the obstacle, providing the rails are directly underneath the top rail, they receive no penalties. A refusal at any of the jumps in a combination results in the horse having to repeat the entire set of obstacles, not just the element refused. So a horse may jump "A" and "B" without issue, but have a refusal at the third fence (C), at which time the rider would have to circle and return to jump fence "A" again, giving the horse a second chance to refuse or knock down "A" and "B". Despite being considered one obstacle; each element may result in penalty points if knocked down. Therefore, if each of the three fences in a triple combination were knocked down, the rider would receive 12 faults (4 per fence, instead of 4 faults for the entire obstacle). Time should be accurately kept between clearly marked starting and ending lines. It is preferable for time to be measured with automatic timer, if not available two timing devices should be used.

4 Fault Penalties

- Refusal. Stopping in front of an obstacle to be jumped, whether or not the horse knocks it down or displaces it, is penalized as disobedience.
- Run-out. Evading or passing the obstacle to be jumped or the finish line or jumping an obstacle outside its limiting markers is penalized as disobedience.
- Loss of Forward Movement. Halting or stepping backward after crossing the start line.
- Circling. Any form of circle or circles whereby the horse crosses its original track between two consecutive obstacles (start and finish included), is considered a disobedience.

Disqualifications: See # 14 under General Rules

Jumps/ Obstacles

Jumper fences often are colorful in design. Rails must be held in cups not deeper than ½" and must be able to freely roll in cups. Types of jumps used include the following:

- Vertical (or upright) – a jump that consists of poles or planks placed one directly above another with no spread, or width, to jump
- Oxer – two verticals close together, to make the jump wider, also called a spread
 - Square Oxer (sometimes known as Box Oxer): both top poles are of an equal height
 - Ascending oxer (usually called a Ramped Oxer): the furthest pole is higher than the first
 - Descending oxer (usually called an Offset Oxer): the furthest pole is lower than the closest

- Swedish oxer: the poles slant in opposite directions, so that they appear to form an "X" shape when seen head on
- Triple bar – is a spread fence using three elements of graduating heights
- Cross rail – two poles crossed with one end of each pole being on the ground and on jump standards so that the center is lower than the sides.
- Wall – this type of jump usually is made to resemble a brick wall, but the "bricks" are constructed of a lightweight material and fall easily when knocked
- Hogsback – a type of spread fence with three rails where the tallest pole is in the center
- Combination – usually two or three jumps in a row, with no more than two strides between each; two jumps in a row are called double combinations, and three jumps in a row are called triple combinations (if a horse refuses the second or third element in one of these combinations, they must jump the whole combination again, not just any obstacle missed)
- Fan: the rails on one side of the fence are spread out by standards, making the fence take the shape of a fan when viewed from above
- Liverpool: a ditch or large tray of water under a vertical or oxer
- Joker: a tricky fence comprising only a rustic (or unpainted) rail and two wings wherein the lack of filler makes it difficult for a horse to judge their proximity to the fence as well as the fence's height.

Class Routine

Classes are held over a course of show jumping obstacles, including verticals, spreads, double and triple combinations, usually with many turns and changes of direction. The intent is to jump cleanly without incurring faults over a set course.

The horse must cross the start and finish line between the markers in the proper direction and with the rider mounted. The horse must jump all of the required fences between the start and finish markers.

A competitor will have 45 seconds from the time the judge(s) sound an audible signal to cross between the start markers in the proper direction and start on course. Not crossing through the start line within the allotted time is cause for elimination. Crossing the start line and beginning the course BEFORE the judge's signal is also grounds for elimination. An audible signal (bell, horn, whistle, gong or buzzer) is sounded for the following purposes:

- a. to give the signal to start
- b. to stop a competitor in the event of an unforeseen incident (which also designates a time-out)
- c. to indicate that an obstacle has to be reset before being retaken after it has been knocked down during a refusal (designating a time-out).
- e. to give the signal for a competitor to continue his round after an interruption.
- f. to indicate by repeated and prolonged ringing that the competitor has been eliminated
- g. to indicate that the rider should not proceed to the jump-off round.

Classes

1. Time First Round:

The first round is decided by the fastest time with the fewest faults incurred over the designated course.

2. Time First Jump-Off:

The first round and first jump-off, if any, are decided by the fastest time with the fewest faults incurred over the designated course. If a competitor has gone clean in the first round, the competitor will, without leaving the ring, and upon an audible signal, commence the designated jump-off course. A competitor who leaves the arena after a clear round (before or after the tone) will be considered to have retired from the jump-off. If there are no clean rounds and a tie exists for first place, there will be one jump-off in which time will decide in the event of equality of faults. It is recommended that no more than ten numbered obstacles be included in the first round.

3. Power and Speed:

The first phase (power) to consist of 8 to 10 jumping efforts and the second phase (speed, or

immediate jump-off) of 5 to 7 jumping efforts. Scores are decided by fastest time with fewest faults in the speed phase, working backward to fastest time in the power phase. If a competitor has gone clean in the first round, he will, upon crossing the finish line, commence the designated jump-off course. Time starts as the horse crosses the finish line for the initial course.

DRESSAGE DIVISION

There are two dressage classes that may be readily incorporated into a standard horse show: Dressage Equitation and Suitable to Become a Dressage Horse. These classes do not require a dressage arena or any special equipment. Although a dressage judge is not mandatory, a judge knowledgeable in dressage should be used.

Because dressage tests require specifically measured and marked arenas with attention to footing, experienced personnel, and explicit timing and tests, it is not recommended to try to incorporate them into a standard horse show. If you are interested in organizing a Dressage Show, please consult the USEF rulebook and contact the United States Dressage Federation (USDF).

Dressage riders should be welcomed into shows where appropriate.

Appointments

1. Rider and Tack

Default to United States Dressage Federation rulebook: USDF.org

Dressage Equitation and Suitable to Become a Dressage Horse

Class Routine for Dressage Equitation

- To be shown at working walk, trot and canter both ways of the ring. The rider's position, seat and specifically the correct use and effect of the aids required by the Training and First Level Dressage tests are to be judged.*
- Movements shall be performed by the exhibitors simultaneously; however, the judge may ask for independent execution of certain tests.*
- Tests are as follows:*
 - Transitions from one gait to the next, both up and down.*
 - Transitions from walk to halt and vice versa.*
 - Transitions from trot to halt and vice versa with or without stirrups.*
 - Judge shall not require exhibitors to exchange horses.*
- Whips and blunt spurs with a strap are allowed. Horses shall be shown in plain snaffle.*
- The size of the class shall not be more than 15 riders.*

Class routine for Suitable to Become a Dressage Horse

- To be shown at a walk, trot and canter both ways of the ring.*
- To be judged on the horse's potential to become a Dressage mount. These qualities are revealed by:*
 - Freedom and regularity of the paces.*
 - Harmony, lightness and ease of the movements.*
 - Lightness of the forehand and the engagement of the hindquarters, originating in a lively impulsion.*
 - Acceptance of the bridle with submissiveness throughout without any tenseness or resistance.*

Disqualifications: See # 14 under General Rules

WESTERN DIVISION

Side Saddle shall be permitted in any class. ASTM/SEI helmets required. Saddle and bridle must be for the same seat ridden. Clothing and appointments should be neat, clean and appropriate for the seat ridden for the show ring. See the International Side-Saddle Organization for specific regulations.

APPOINTMENTS

Required

1. ASTM/SEI Helmet when mounted, helmet or Western style hat for fitting & showmanship.
2. Shirt or jacket with long sleeves. It may be short-sleeved shirt if the rider is also wearing a jacket. Other western attire in accordance with breed standards is allowed.
3. Western style pants or colored jeans must be clean, neat, and in good repair.
4. Appropriately heeled riding boots.

Preferred

Western boots

Optional

1. If vest or jacket is worn, it should be a definite western design.
2. Spurs must have blunt rowels or no rowels and straps. Bluntness is at the discretion of the judge. No slide on western spurs allowed.
3. Chaps
4. Standard sliding, rundown, or skid boots on the rear fetlocks; splint boots and bell boots on the front legs or soft wraps on either are optional appointments in Western Reining and Western Handiness. They are prohibited in all other Western classes.
5. Gloves
6. Any protective safety equipment for the rider (protective vest, other

Tack/Equipment

1. The horse will be shown with a stock saddle, either slick or swelled with either a high or low cantle. However, the saddle must definitely be sized to fit both the rider and the horse. Silver equipment will not count over a good working outfit. Tapaderos and Australian stock saddles are prohibited.
2. The horse will be shown with a properly fitted western bridle and bit. The bridle should be as simple as possible with no Cavesson or drop nosebands being allowed. The bit will be a Standard Western bit of either solid or jointed mouthpiece. Standard Western bits may have either a leather or chain curb strap; either must be at least half an inch or wider and lie flat.
3. Any horse five and under as of Jan 1st of the current year; may be shown in a Bosal or snaffle. A bosal must be rounded in shape, constructed of braided leather or rawhide, and must have a flexible, non-metallic core attached to suitable headstall. Attached reins may be of hair, rope or leather. A standard snaffle bit is defined as a jointed, single, rounded, smooth mouthpiece; rings may be loose, egg butt, Dee, or center mounted. It is recommended but not required to use a leather (not chain) curb strap with a snaffle bit to be placed below the rein. A bosal, hackamore or snaffle bit rider may ride with two hands.
4. Romal, or standard, leather or woven split reins are acceptable. Index finger only between split reins. When using a romal, no fingers between the reins are allowed. See figures 1-3. Roping or contest reins are allowed in Gymkhana classes only.
5. Tie-downs, running martingales are prohibited in non-contest (Gymkhana) classes.
6. The position of the hand not being used for reining is optional; but it should be kept free of the horse and equipment and held in a relaxed manner. Switching of hands is not allowed in non-trail classes.

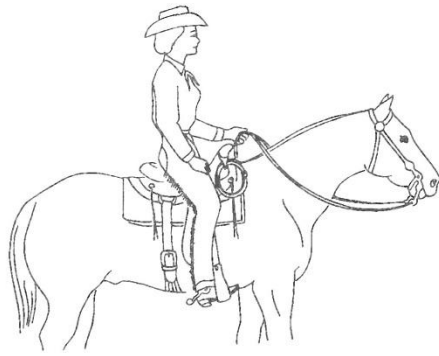
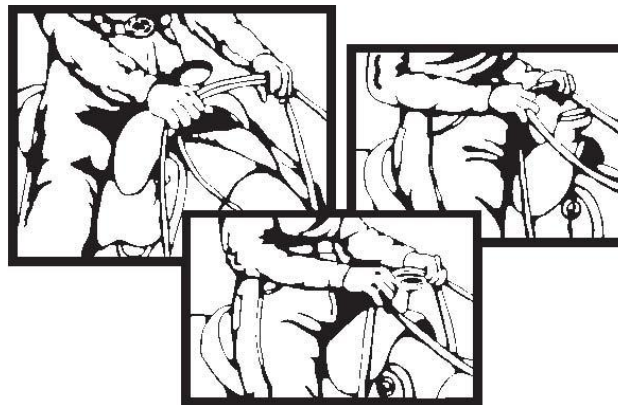

Figure 1: Illustrates hands when using split reins. Index finger must be between the reins prior to the fist portion of the hand. When using split reins and a curb bit if the second hand touches reins at any time this is cause for elimination.



Figure 2: Illustrates hands when Romal is used. 16" of rein must be between hands, bite of reins optional as to coil or straight. No fingers in-between rein

Figure 3: Illustrates hands when using a snaffle bit and split reins. The reins must be crossed or bridged as shown here. When using a bosal, the rider must have both hands on the reins. Rider's hands should be carried near the pommel and not further than four (4) inches out on either side of the saddle horn, with very limited movement



WESTERN HORSEMANSHIP (EQUITATION)

Class Routine

Recommended to be shown both ways of the ring in appropriate gaits including but not limited to: walk, trot, extended trot, canter, hand gallop, reverse. Riders may be required to execute any appropriate pattern as requested by the judge. Appropriate patterns will be provided either by the show committee or the judge at the discretion of the show committee which they feel are appropriate to the caliber of the class. Patterns chosen shall be required of all riders selected for this additional performance.

The method of holding the reins is explained and shown in the tack/equipment section number 5 above. Incorrect rein holds will be grounds for disqualification.

Judging/Scoring

Class to be judged on seat, hands, suitability of horse to rider, and the performance of the horse as it reflects the riding skill of the exhibitor. To be judged 90% on the rider's position, use of aids and cues, and control of the horse, and 10% on personal appointments and tack. The scoring of personal appointments and tack will be based on neatness of clothing rather than newness or expense, and cleanliness, condition and adjustment of tack.

Disqualifications: See # 14 under General Rules

WESTERN PLEASURE

Class Routine

A true pleasure horse is easy to handle, smooth gaited and does not show undesirable mannerisms. Overall performance should be smooth, consistent and obedient.

1. All horses enter the ring in a counterclockwise direction. All horses will be asked to walk, jog and lope both ways of the ring. Horses will be asked to back, may be asked to extend the jog.
2. After all the horses have been worked; the judge may then excuse those not to be considered further in the class.
3. The judge may ask for additional rail work from any of the remaining horses.
4. The method of holding the reins is explained and shown in the tack/equipment section number 5.

Judging/Scoring

To be judged on manners, and performance and suitability of the horse as a pleasure mount. The smoothness, obedience and consistency of the performance will be considered rather than brilliance and animation.

Disqualifications: See # 14 under General Rules

WESTERN RIDING

Class Routine

This class is a competition in the performance of a sensible, well-mannered, free and easy going ranch horse which can get its rider around on the usual ranch chores, over trails, or give a quiet, comfortable and pleasant ride in open country and over obstacles.

1. All horses will follow the posted pattern. Any horse not following the exact pattern may be penalized or disqualified at the discretion of the judge.
2. The X's on the pattern represent markers (plastic or rubber cone-shaped markers recommended). These should be spaced a uniform distance apart. The preferred distance lengthwise between the markers is 40 feet, but if arena space is limited, they may be spaced 30 feet apart. Width-wise there should be a distance of 60 feet when the length is 40 feet and a distance of 50 feet when the length is 30 feet.
3. The rectangle represents an obstacle just high enough to break the horse's stride. This obstacle, if possible, should be at least 12 inches high and not more than 18 inches high. A small log is recommended. A ground pole may be used if a more suitable obstacle is unavailable.
4. The long and sometimes twisting line indicates the direction to travel and the gaits at which the horse is to move. The dotted line (...) indicates the walk, the dash line (---) the jog, the solid line (___) the lope.
5. If the horse runs into a marker, he will be penalized but not disqualified.
6. The method of holding the reins is the same as that for Stock Seat Equitation.
7. While the horse is in motion, the rider's hands will be clear of the horse and saddle.
8. Spurs or Romal will not be used forward of the cinch.
9. Leg coverings not allowed.
10. For all patterns simple lead changes will be allowed, however; flying lead changes will be given preference and will be reflected in the scoring of all patterns.

Judging/Scoring

The horse in this class will be judged on riding quality and smoothness of gaits, changes of lead, response to rider, manners, disposition, and intelligence. The horse should execute flying lead changes quietly and smoothly. Contestants will be penalized when the horse changes leads in the front but not behind and when horse shows signs of resistance to lead changes (tail-wringing, head tossing, etc.). When the horse is asked to go over the obstacle, it should do so smoothly and calmly; when asked to back, it should do so in a relaxed, obedient manner.

Disqualifications: See # 14 under General Rules

WESTERN RIDING PATTERNS

Pattern I

WESTERN RIDING PATTERN I

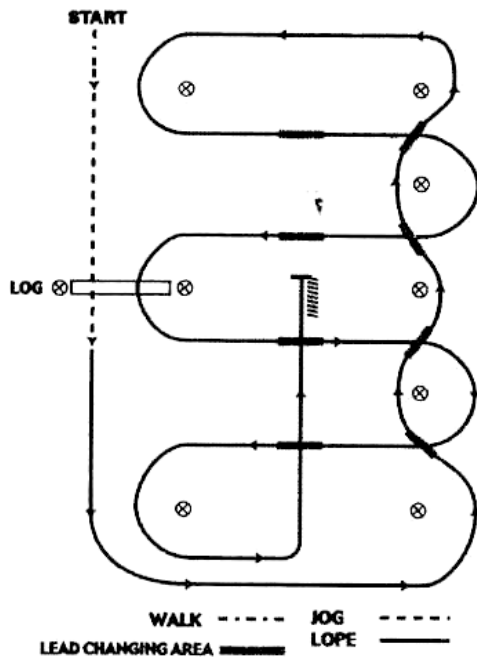

Pattern II

WESTERN RIDING PATTERN II

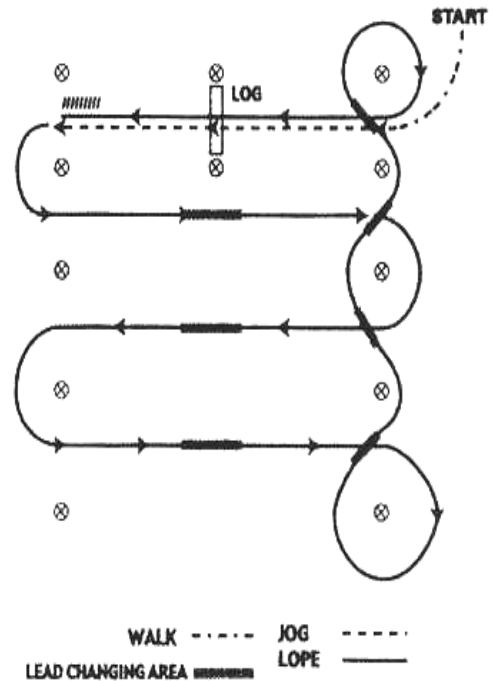

Pattern I

1. Walk and jog over log.
2. Transition to left lead and lope around end.
3. First line change.
4. Second line change.
5. Third line change.
6. Fourth line change lope around the end of arena.
7. First crossing change.
8. Second crossing change.
9. Lope over log.
10. Third crossing change.
11. Fourth crossing change.
12. Lope up the center, stop and back.

Pattern II

1. Walk, transition to jog, jog over log.
2. Transition to left.
3. First crossing change.
4. Second crossing change.
5. Third crossing change.
6. Circle and first line change.
7. Second line change.
8. Third line change.
9. Fourth line change and circle.
10. Lope over log.
11. Lope, stop and back.

For all patterns simple lead changes will be allowed, however; flying lead changes will be given preference and will be reflected in the scoring of all patterns

Pattern III

WESTERN RIDING PATTERN III

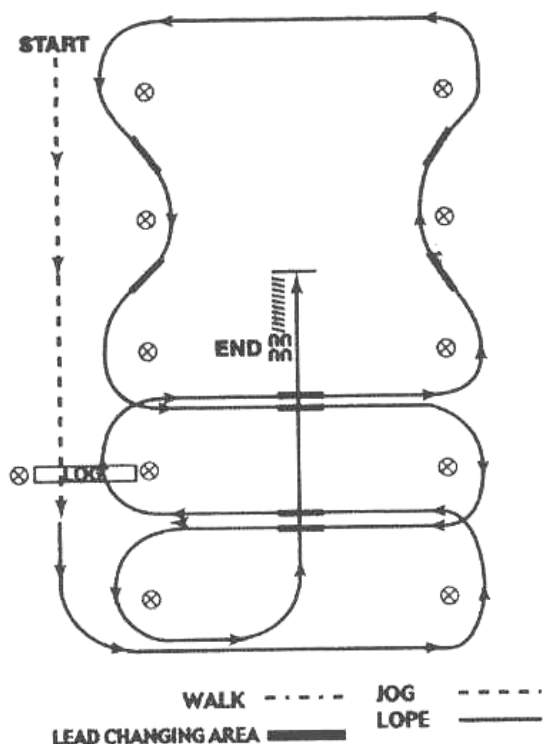

Pattern III

1. Walk, transition to jog, jog over log.
2. Transition to left.
3. First crossing change.
4. Lope over log.
5. Second crossing change.
6. First line change.
7. Second line change.
8. Third line change.
9. Fourth line change.
10. Lope over log.
11. Third crossing change.
12. Fourth crossing change.
13. Lope up the center, stop and back.

Pattern IV

WESTERN RIDING PATTERN IV

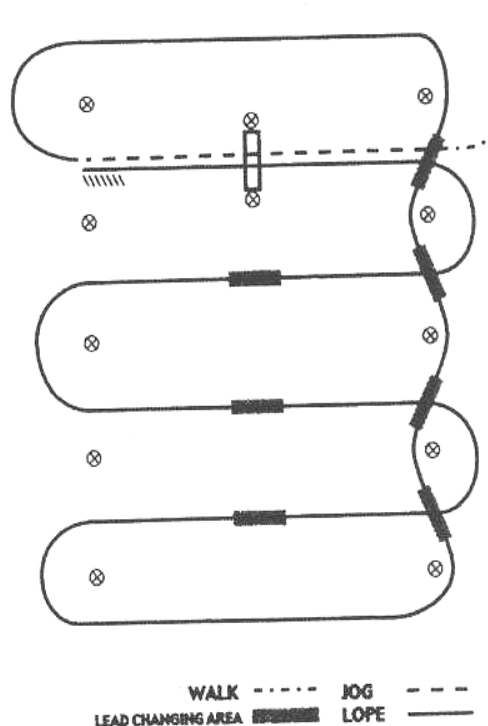

Pattern IV

1. Walk, transition to jog, jog over log.
2. Transition to right.
3. First line change.
4. Second line change.
5. Third line change.
6. Fourth line change.
7. First crossing change.
8. Second crossing change.
9. Third crossing change.
10. Lope over log.
11. Lope, stop and back.

For all patterns simple lead changes will be allowed, however; flying lead changes will be given preference and will be reflected in the scoring of all patterns

WESTERN REINING

Class Routine

The judge will indicate with markers on the arena fence or wall the length of the pattern. Markers within the area of the pattern will not be used. As each maneuver group is completed, the judge will make an assessment in accordance with the following scale:

+ 1 ½	Excellent
+1	Very good
+1/2	Good
0	Correct
-1/2	Poor
-1	Very Poor
-1 ½	Extremely poor

These maneuver group scores are added to the starting score of 70 and from that gross score all penalties are subtracted to arrive at a final score.

GROSS SCORE (70 points. + Maneuver Group Score) Less PENALTIES = FINAL SCORE

Maneuvers

1. **Stops:** Stops are the act of slowing the horse from a lope to a stop position by bringing the hind feet and hocks under the horse in a locked position and sliding on the rear shoes. The horse should enter the stop position by bending the back and bringing the rear legs and hocks further under the body while maintaining forward motion and ground contact with the front legs. Throughout the stop, the horse should continue in a straight line and the position of the hocks, rear feet, and back should not vary.
2. **Spins:** Spins are a series of turns, executed over a stationary (inside) hind leg. Propulsion for the spin is supplied by the outside hind leg and front legs, and contact should be made with the ground and a front leg. The location of the hindquarters should be fixed at the start of the spin and maintained throughout.
3. **Rollbacks:** Rollbacks are the 180° reversal of forward motion completed by running to a stop, rolling (turning) the shoulders back to the opposite direction over the hocks and departing in a lope, as one continuous motion. The rollback must be executed with not more than slight hesitation after the stop, and the horse should not step ahead or back prior to the rollback.
4. **Circles:** Emphasis on scoring shall be given to the contestant exhibiting smooth, controlled figure eights with easy lead changes. Circles are a controlled maneuver at the lope in the designated area of the arena. Right and left circles shall have a common centerline in the middle of the designated area. Circles shall be run and/or begun on the correct lead. The speed and size of the right circles shall be exactly the same as the speed and size of the left circles. The horse shall lope in an even, fluid manner with a minimum of rider contact and/or commands. Circles shall be run far enough from arena wall that it does not affect the circles.
5. **Backups:** A back up is maneuvers requiring the horse to be moved in a reverse motion in a straight line a required distance (i.e. at least 10 feet).
6. **Hesitate:** Hesitation is only long enough to show the completion of one maneuver before the next one starts. There shall be the slightest hesitation to indicate each maneuver.
7. **Lead Changes:** Lead changes are the act of changing the leading legs of the front and rear pair of legs, at a lope, when changing the direction traveled. The lead change must be executed at the lope with no change of gait or speed and be performed in the exact geographical location in the arena specified in the pattern description. The change of front and rear legs must take place within the same stride to avoid penalty.

8. **Run Downs**: Run downs are the run through the middle of the arena, runs from the center of the arena to the end, and runs along the side and ends of the arena.
9. **Disqualifications**: See # 14 under General Rules

Penalties

Half-Point Penalties

1. Not changing leads in the same stride.
2. Over or under spin 1/8 turn.
3. Jogging first two strides.
4. Failure to be a minimum of 20 feet from wall or fence when approaching a stop and/or rollback.

1 Point Penalties

1. Not changing leads each quarter circle.
2. Slipping a rein in the bridle.
3. Scotching or anticipating a stop.
4. Over or under spinning up to quarter turn.
5. Lead missed around end of arena first corner to top.
6. Out of leads for each quarter circle.
7. Not picking up the correct lead for the first quarter circle.

2 Point Penalties

1. Lead missed around end of arena past 2nd corner.
2. Not ever-changing leads in pattern where there is only half circle.
3. Failure to run by markers before stop is initiated.
4. Freezing up in turn or rollback.
5. Breaking gait.
6. Jogging beyond two strides.

4 Point Penalties

1. Not ever-changing leads in a complete circle.

5 Point Penalties

1. Spurring or hitting front of cinch.
2. Blatant disobedience including kicking, biting, bucking, rearing, and striking.
3. Holding any part of the saddle with either hand.
4. Use of either hand to instill fear or praise.

0 Score

1. Failure to complete the pattern given (i.e., over or under spin more than quarter).
2. Using 2 hands on the reins in a bridle or two-rein class.
3. Use of more than the index/first finger between the reins in a bridle class, except in the two-rein class.
4. Horse balking
5. Failure to maintain 16 inches of rein between hands using Romal reins
6. Use of free hand while holding a Romal to alter the tension or length of reins from the bridle to the reining hand
7. Leaving the working area before pattern is complete
8. Backing more than 2 strides, when back is not the maneuver being performed.

Judging/Scoring

The arena or plot should be 50 x 150 in size.

1. The pattern to be used will be posted by the judge at least 1 hour prior to the competition. It shall be a pattern from this rulebook.
2. Protective boots, leg wraps and bandages are permitted.
3. A suggested pattern is shown (see diagram in this section).
4. **Scoring:**
 - a. Scoring will be on the basis of 60 - 80 with 70 denoting an average performance. To be judged on the neatness, precision, dispatch, ease, calmness, and speed with which the pattern is performed. Off pattern will result in disqualification.
 - b. **Faults against the horse** (to be scored accordingly, but not to cause disqualification):
 - i. Opening mouth excessively when wearing a bit.
 - ii. Excessive jawing, opening mouth or head rising on stop.
 - iii. Breaking gaits.
 - iv. Lack of smooth, straight stop on haunches (bouncing or sideways stop).
 - v. Failure to change leads.
 - vi. Anticipating signals.
 - vii. Stumbling or falling.
 - viii. Backing sideways.
 - ix. Knocking over markers.
 - c. **Faults against the rider** (to be scored accordingly, but not to cause disqualification).
The judge can assume infractions of these rules are due to lack of control on the part of the rider:
 - iii. Holding on to any part of the saddle.
 - iv. Any unnecessary aid given by rider (such as excessive talking, spurring, whipping, jerking of reins, etc.).
 - d. **Disqualifications:**
 - i. Off course
 - ii. Horse being unruly or out of control.
 - iii. See #14 under General Rules

WESTERN REINING PATTERNS

Pattern 1

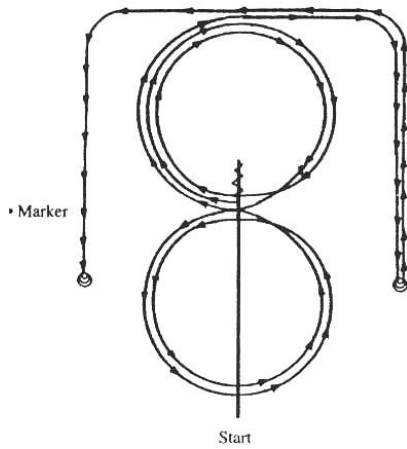

Pattern 1

1. Start at end of arena. Run down middle past center marker to a sliding stop.
2. Back up 10-15 feet to center, quarter turn left.
3. Pick up right lead, big fast circle, and small slow circle.
4. Change leads to left, big fast circle, small slow circle.
5. Change leads to right, do not close this circle.
6. Run around end of arena and down the side (approximately 20 feet from fence) past center marker and come to a sliding stop.
7. Complete $3\frac{1}{2}$ spins to right.
8. Continue back downside and end of arena to other side (approximately 20 feet from fence) go past center marker and come to a sliding stop.
9. Complete $3\frac{1}{2}$ spins to the left.
10. Hesitate to complete pattern.

Pattern 2

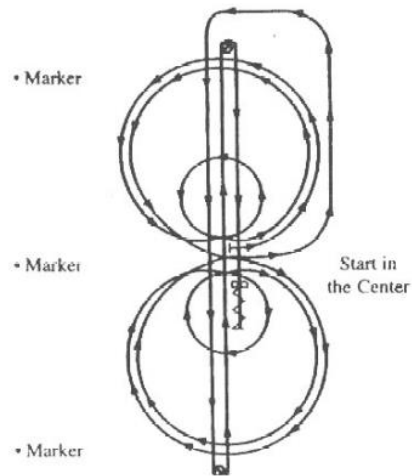

Pattern 2

1. Trot to center of arena, stop. Pick up left lead; complete three circles to the left. The first one large and fast, the second small and slow, the third large and fast
2. Leads at center of arena.
3. Complete three circles to the right. The first one large and fast, the second small and slow, the third large and fast
4. Change leads at center of arena.
5. Do not stop, continue on to run-downs.
6. Run to far end past the marker to a sliding stop. Hesitate.
7. Complete $2\frac{1}{2}$ spins to the left. Hesitate.
8. Run to far end past the marker to a sliding stop. Hesitate.
9. Complete $2\frac{1}{2}$ spins to the right. Hesitate.
10. Run past center marker to a sliding stop. Hesitate.
11. Back 10-15 feet in a straight line. Hesitate.
12. Make 2 full spins each way, either way first. Hesitate between spins.
13. Hesitate to complete pattern.

Pattern 3

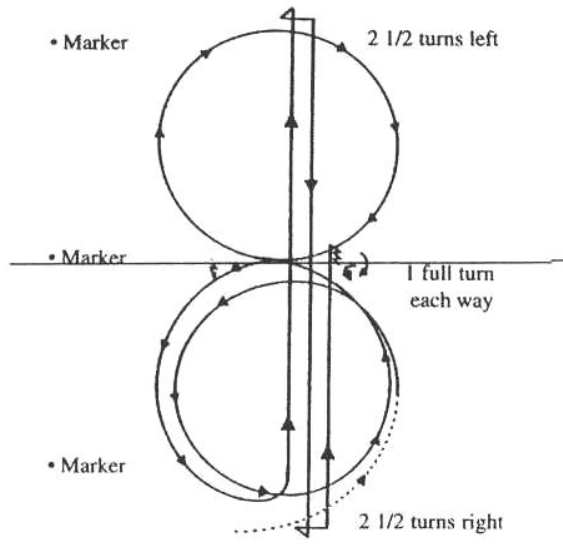

PATTERN 3

1. Start at center of arena.
2. Begin on left lead, complete one circle, change to the right.
3. Complete one circle to the right, change leads to the left.
4. Do not stop; continue loping to end of arena without breaking gait.
5. Run to far end past the marker and come to a sliding stop.
6. Complete 2½ spins to left.
7. Run to far end past the marker, come to a sliding stop.
8. Complete 2½ spins to the right.
9. Run back to middle of the arena past the center marker and come to a sliding stop.
10. Back 10-15 feet in straight line.
11. Complete one full turn each way, either way first.
12. Hesitate to complete the pattern.

Pattern 4

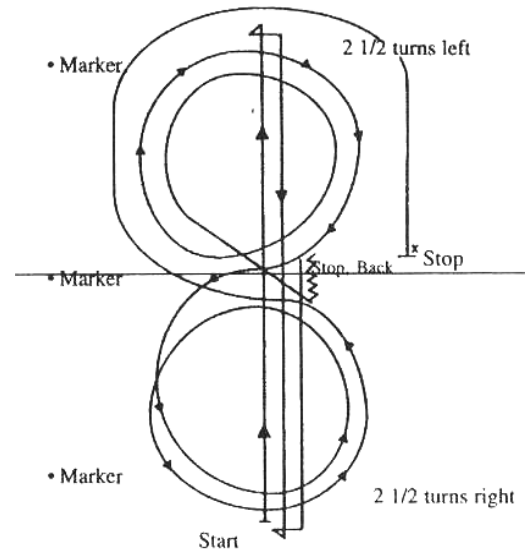

PATTERN 4

1. Start at end of arena.
2. Run to far end of arena past the end marker and stop. Complete 2½ spins to the left.
3. Run to other end of arena past the end marker and stop. Complete 2½ spins to the right.
4. Run past the center marker and stop.
5. Back 10-15 feet in straight line.
6. Complete ¼ turn to the left, hesitate. Begin on right lead, circle to the right.
7. Complete one small, slow circle and one large, fast circle. Change leads to the left.
8. Complete one small, slow circle and one large, fast circle. Change leads to the right.
9. Run around end of arena to the other side, past center marker, at least 20 feet from fence and stop.
10. Hesitate to complete pattern.

Pattern5

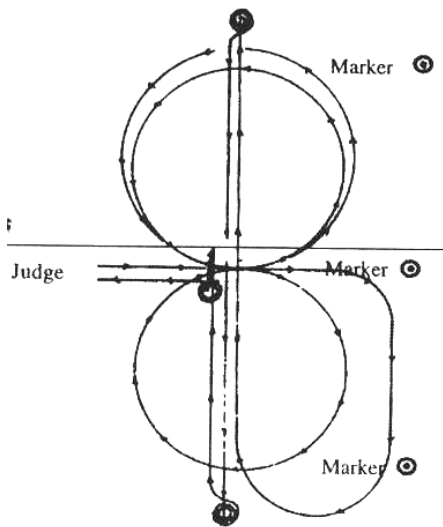

PATTERN 5

1. Begin at the center of the arena, facing right wall or fence. Take a right lead and complete a circle to the right, away from the judge.
2. At the center of arena, change leads and do two circles to the left of approximately the same size.
3. At the center of arena, change leads.
4. Go to the end of the arena and without stopping or breaking gait, start the run near the approximate center marker of the arena. Run full length of arena.
5. Do a square sliding stop, hesitate.
6. Do 2½ spins right.
7. Run full length of arena past marker and do a square sliding stop, hesitate.
8. Do 2½ spins left.
9. Run past center marker of arena; do a square sliding stop.
10. Back to center of arena (minimum 10-15 feet).
11. Do a 360° spin right or left.
12. Do a 360° spin opposite direction taken in #11.
13. Hesitate to show completion of pattern.

Pattern 6

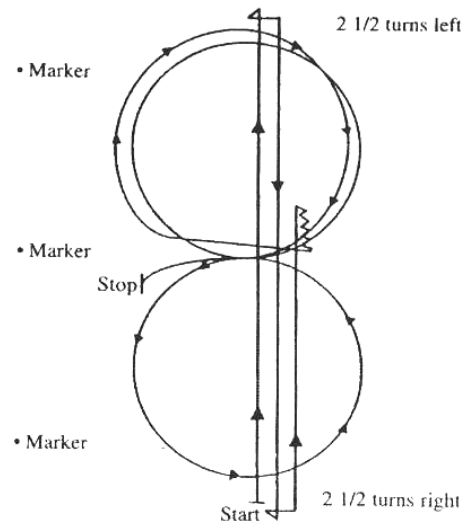

PATTERN 6

1. Start at end of arena.
2. Run down the idle of the arena, past the end marker and come to a sliding stop.
3. Complete 2½ spins to the left.
4. Run to the other end of the arena past the end marker and come to a sliding stop.
5. Complete 2½ spins to right.
6. Run back to middle of the arena, past the center marker and stop.
7. Back 10-15 feet, hesitate.
8. Complete ¼ turn to the left.
9. Start to circle to the right, change leads in the middle to the left leads. Complete circle and change to the right leads. Close circle and stop.
10. Hesitate to complete pattern.

Pattern 7

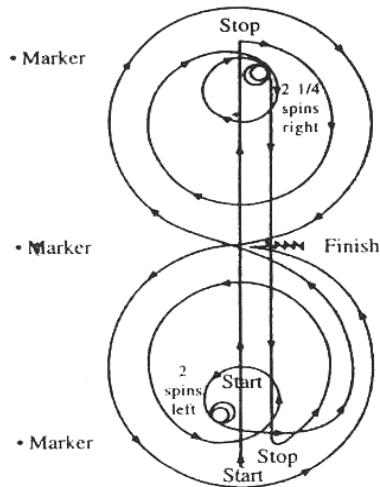

PATTERN 7

1. Proceed to end of arena. Run down in the middle of the arena, past end marker and come to a sliding stop. Hesitate.
2. Complete $\frac{1}{4}$ turn to the right, pick up right lead, and make one large, fast circle and one small, slow circle. Stop.
3. Complete $2\frac{1}{4}$ spins to the right. Hesitate.
4. Run down to end of arena, past end marker and come to a sliding stop. Hesitate.
5. Complete $\frac{1}{4}$ turn to the left, pick up left lead and make one large, fast circle and one small, slow circle. Stop.
6. Complete 2 spins to the left. Hesitate.
7. Pick up left lead to make one figure eight, change in center of arena to right lead. Proceed back to center of arena and change leads to the left. Close circle, stop.
8. Back 10-15 feet.
9. Hesitate to complete pattern.

Pattern 8

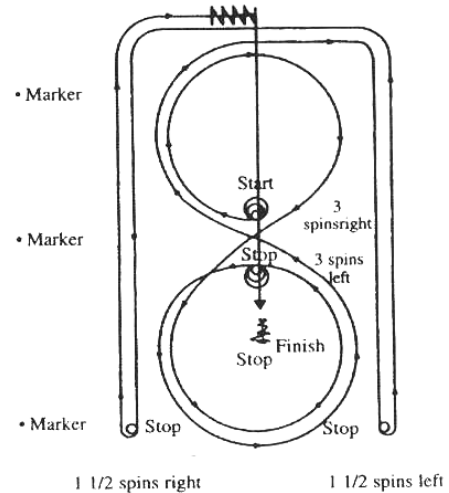

PATTERN 8

1. Start in center of arena and complete 3 spins to the right. Hesitate.
2. Begin on right lead, complete one circle to the right, change leads to the left, close this circle and stop.
3. Complete 3 spins to the left. Hesitate.
4. Begin on left lead, circle to the left, change leads to the right.
5. Do not close this circle. Run straight downside of arena approximately 20 feet from the fence, past end marker and come to a sliding stop.
6. Complete $1\frac{1}{2}$ spins to the left.
7. Continue back downside of arena approximately 20 feet from fence, around end of arena (horse should be on the left lead at this point). Run straight down other side of arena approximately 20 feet from fence, past end marker and come to a sliding stop.
8. Complete $1\frac{1}{2}$ spins to the right.
9. Continue back downside of arena approximately 20 feet from fence, around the end of arena (horse is to be on the right lead at this point). Run straight down middle of arena, past middle marker and come to a sliding stop.
10. Back 10-15 feet.
11. Hesitate to complete pattern.

WESTERN HANDINESS

Appointments/Tack/Equipment

Same as the Western Division with the addition of a costume and music. For New England Show at Eastern States Exposition the music must be screened by your state leader prior to using it.

Class Routine

This class is a pattern class. It is the exhibitor's responsibility to be prepared to perform the posted pattern. This class is neither a stunt class nor a race but should be performed with reasonable speed. It is a completion in the performance and characteristic of a good, sensible, well-mannered, free and easy moving horse. Horses will be judged on riding qualities of gaits, response to rider, and manners and disposition. Maximum time limit for each exhibitor is 3 minutes.

Judged Requirements as well as those in the posted pattern for 5 points each

- a. Horse's quality of gaits.
- b. Horse's response to rider in executing pattern.
- c. Manners and disposition of horse.
- d. Theming of music and costume
 - 4-H appropriate content (follow the 4-H ESE dress code in ESE section of this rulebook)

Judging/Scoring

This class starts when the exhibitor enters the arena/ring and judging will cease after the last maneuver.

Disqualifications

1. The following will result in disqualification:
 - a. Abuse of animal in show arena/ring and/or evidence that an act of abuse has occurred prior to or during the exhibition of the horse in competition.
 - b. Use of illegal equipment
 - c. Use of whips or bats.
 - d. Use of any attachments which alters the movement of, or circulation to, the tail.
 - e. Failure to provide horse and equipment to the appropriate judge or official for inspection.
 - f. Disrespect or misconduct by the exhibitor.
 - g. Failure to complete the pattern in the specified order.
 - h. See #14 under General Rules

Penalties

The following will result in a reduction of exhibitor's score.

1. Balking or refusal of a command where the pattern is delayed.
2. Jogging in excess of half circle or half the length of the arena.
3. Backing more than 2 strides, when back is not the maneuver being performed.

If technical difficulties occur with the music, which is beyond the rider's control, it will be at the discretion of the judge whether the rider may re-start.

Handiness Pattern #1

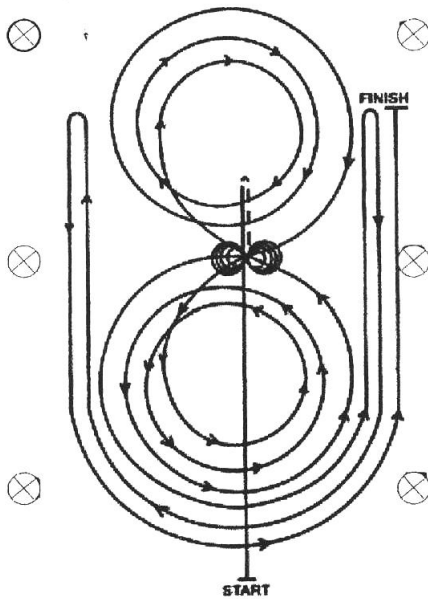

1. Jog to center marker and stop
2. Back up 5 steps and hesitate for 5 seconds
3. Complete 360 degree turn to the right
4. Complete 360 degree turn to the left
5. Pivot to the left 90 degrees
6. On the left lead complete 3 circles to the left, first small and slow and the next two large and fast; change leads at center of arena
7. On the right lead complete 3 circles to the right, first small and slow and the next two large and fast; change leads at center of arena
8. Begin a large fast circle to the left but do not close this circle, run or lope up the right side of the arena past the center marker and do a right rollback at least 20 feet (6 meters) from the wall or fence – no hesitation
9. Continue back around the previous circle but do not close this circle. Run or lope up left side of the arena past the center marker and do a left rollback at least 20 feet (6 meters) from the wall or fence – no hesitation
10. Continue back and around previous circle but do not close this circle. Run or lope up right side of the arena past the center marker and stop at least 20 feet (6 meters) from the wall or fence. Stop and hesitate to demonstrate completion of the pattern

**Simple changes are accepted but flying changes are preferred.
Scoring will reflect such.**

Rider may be asked to drop the bridle to the designated judge

Adopted from the AMERICAN QUARTER HORSE ASSOCIATION Reining Pattern #9

Handiness Pattern #2

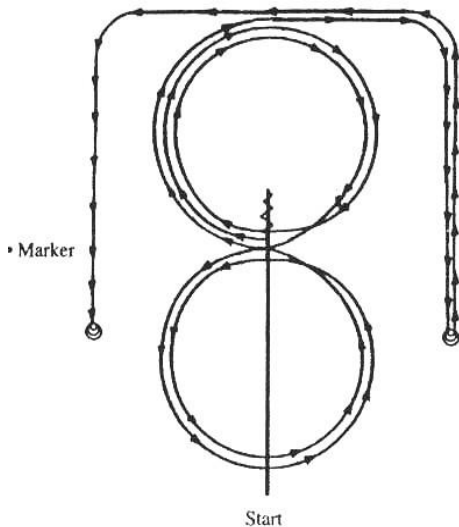

1. Jog to center marker and stop.
2. Back up 10-15 feet to center, quarter turn to the left.
3. Pick up right lead, big fast circle, and small slow circle.
4. Change leads to the left, big fast circle, small slow circle.
5. Change leads to right, do not close this circle.
6. Run or lope around end of arena and down the side (approximately 20 feet from fence) past center marker and come to a stop.
7. Complete 3 ½ 360° turns to the right.
8. Continue back down the side and end of arena to the other side (approximately 20 feet from fence) go past center marker and come to a stop.
9. Complete 3 ½ 360° turns to the left.
10. Hesitate to complete pattern.

**Simple changes are accepted but flying changes are preferred.
Scoring will reflect such.**

Rider may be asked to drop the bridle to the designated judge

Adopted from the AMERICAN QUARTER HORSE ASSOCIATION Reining Patterns

RANCH HORSE DIVISION

The purpose of the Ranch Horse Division is to showcase the versatility, attitude and movement of a western working horse. Open to horses three years and older.

Appointments

Required

1. ASTM/SEI Helmet when mounted.
2. Shirt or jacket with long sleeves or other Western attire in accordance with breed standards is allowed. Neat and clean working type attire.
3. Western style pants or jeans that are clean, neat and in good repair.
4. Western boots preferred, appropriate heeled riding boots are acceptable.

Optional

1. Vest or jacket of western working design
2. Spurs with straps, blunt rowels or no rowels. Bluntness is at the discretion of the judge. No slide on western spurs allowed
3. Chaps or chinks
4. Gloves
5. Standard sliding, rundown or skid boots on the rear fetlocks; splint boots and bell boots on the front legs or soft wraps on either are optional appointments in Ranch Riding. They are prohibited in all other Ranch classes.
6. Any protective safety equipment for the rider (protective vest, other)

Tack/Equipment

1. Horses are to be shown in a western stock saddle and a standard western bridle. Silver equipment is discouraged and shall not count over good working equipment. Tapaderos and Australian stock saddles are prohibited.
2. Tie downs, cavessons, mechanical hackamores and running martingales are prohibited.
3. Hoof polish, black is discouraged.
4. No braided or banded manes or tail extensions.
5. Trimming inside ears is discouraged.
6. Trimming bridle path, fetlocks or excessively long facial hair is allowed.
7. Only one hand may be used on the reins, except for junior horses shown with an acceptable snaffle bit or hackamore/bosal, in accordance with traditional western split or romal rein positions. While horse is in motion, hands shall be clear of the horse and saddle, except that it is permissible to hold the saddle horn with either hand.
8. Posting at the extended trot is acceptable.

RANCH HORSE PLEASURE

This class is intended as a rail class, but individuals riding off the rail will not be penalized. The ranch horse pleasure class measures the ability of the horse to be a pleasure to ride while being used as a means of conveyance from one ranch task to another and should reflect the versatility, attitude, and movement of a working horse. The horse should be well-broke, relaxed, quiet, soft and cadenced at all gaits. This class should show the horse's ability to work at a forward, working speed while under control by the rider. Light contact should be rewarded and horse shall not be shown on a full drape of reins.

Class Routine

To be shown at the walk, trot, extended trot and lope both ways of the ring. Horses must stand quietly and back readily. All horses may be asked to extend the walk and lope. Other optional maneuvers are stop, reverse at the trot, 180 degree reverse.

Judging/Scoring

The overall manners and responsiveness of the horse while performing the maneuver requirements and the horse's quality of movement are the primary considerations. Part of the evaluation of this class is on the smoothness of both upward and downward transitions. Judges expect to see horses that have been trained to respond to cues. To see these cues applied discretely and the horse responding correctly could be a credit earning situation. Areas of penalty include: too slow/per gait, over-bridled, out of frame, breaks of gait, wrong leads, blatant disobediences, excessive trotting when taking lead.

Disqualifications: See #14 under general rules.

RANCH RIDING

The ranch riding horse should reflect the versatility, attitude and movement of a working horse. The horse's performance should simulate a horse riding outside the confines of an arena and that of a working ranch horse. This class should show the horse's ability to work at a forward working speed while under control by the rider. Light contact should be rewarded and horse shall not be shown on a full drape of reins. The overall manners, responsiveness of the horse while performing the maneuver requirements and the horse's quality of movement are the primary considerations. This is a pattern class.

Judging/Scoring

1. Each horse will work individually, performing both required and optional maneuvers and scored on the basis of 0 to 100, with 70 denoting an average performance.
2. The required maneuvers will include the walk, trot and lope in both directions, the extended trot and extended lope in at least one direction, stops and backs.
3. Three optional maneuvers may include a side pass; turns of 360-degrees or more; a change of lead (simple or flying); walk, trot, or lope over a pole or poles; or some combination of maneuvers that would be reasonable for a ranch horse to perform.
4. The overall cadence and performance of the gaits should be with an emphasis on forward movement, free-flowing, and ground covering for all gaits. Transitions should be performed where designated, with smoothness and responsiveness.
5. No time limit.
6. One of the suggested 4 patterns may be used, however a judge may utilize a different pattern as long as all required maneuvers are included plus 3 or more optional maneuvers are included.
7. Failure to perform a required maneuver will result in a horse placing below all other horses that perform all maneuvers.

The judge will assess each maneuver with the following scale:

- +1 ½ = Excellent
- +1 = Very Good
- +1/2 = Good
- 0 = Correct
- ½ = Poor
- 1 = Very Poor
- 1 ½ = Extremely Poor

Penalties

1. One (1) point penalties
 - a. Too slow/per gait
 - b. Over-bridled
 - c. Out of frame
 - d. Break of gait at walk or trot for 2 strides or less
 - e. Split log at lope
2. Three (3) point penalties
 - a. Break of gait at walk or trot for more than 2 strides
 - b. Break of gait at lope
 - c. Wrong lead or out of lead
 - d. Draped reins
 - e. Out of lead or cross cantering more than 2 strides when changing leads
 - f. Trotting more than 3 strides when making simple lead change
 - g. Severe disturbance of any obstacle
3. Five (5) point penalties
 - a. Blatant disobedience (kick, bite, buck, rear, etc.) for each refusal
 - b. Use of either hand to instill fear or praise
4. Placed below horses performing all maneuvers (OP)
 - a. Eliminates maneuver
 - b. Incomplete maneuver
5. Zero (0) score
 - a. Illegal equipment (including braided or branded manes or tail extensions)
 - b. Willful abuse
 - c. Major disobedience or schooling
6. No specific penalties will be incurred for nicks/ hits on logs but a deduction may be made in the maneuver score.
7. No specific penalties will be incurred for over/ under spins but a deduction may be made in the maneuver score.

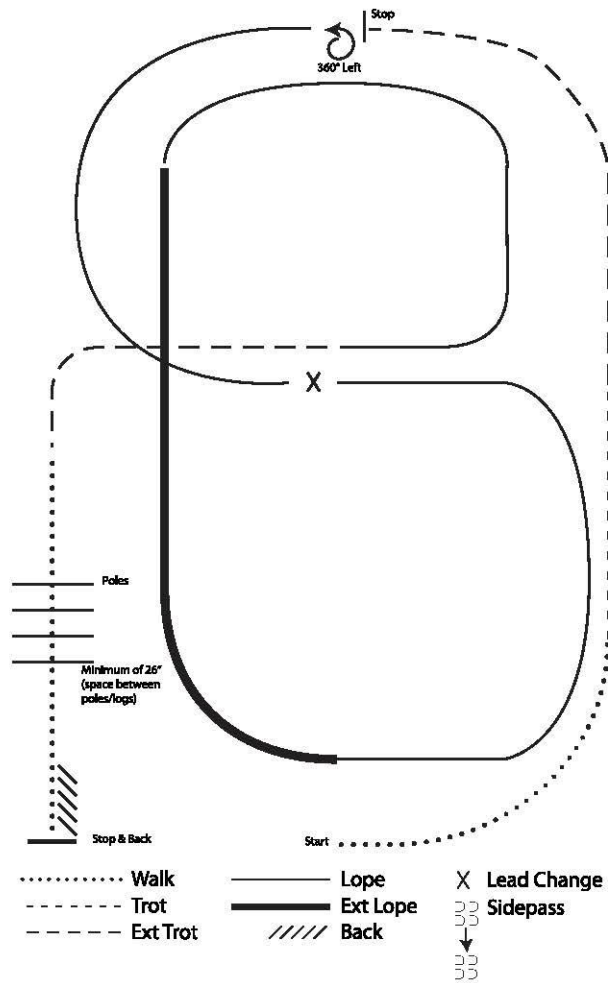

RANCH HORSE RIDING PATTERN I

1. Walk
2. Trot
3. Extend the trot, at the top of the arena, stop
4. 360 degree turn to the left
5. Left lead ½ circle, lope to the center
6. Change leads (simple or flying)
7. Right lead ½ circle
8. Extended lope up the long side of the arena (right lead)
9. Collect back to a lope around the top of the arena and back to center
10. Break down to an extended trot
11. Walk over poles
12. Stop and back

Pattern adapted from the Appaloosa Horse Club Ranch Riding Patterns.

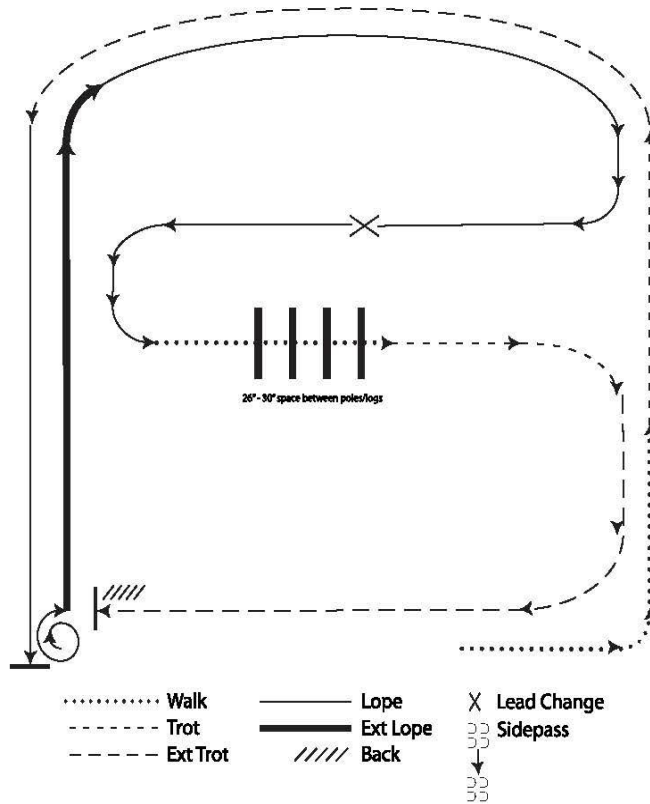

RANCH HORSE RIDING PATTERN 2

1. Walk
2. Trot
3. Extended trot
4. Left lead lope
5. Stop, 1 ½ turn right
6. Extended lope
7. Collect to working lope-right lead
8. Change leads (simple or flying)
9. Walk
10. Walk over logs
11. Trot
12. Extended trot
13. Stop and back

— Pattern adapted from the Appaloosa Horse Club Ranch Riding Patterns.

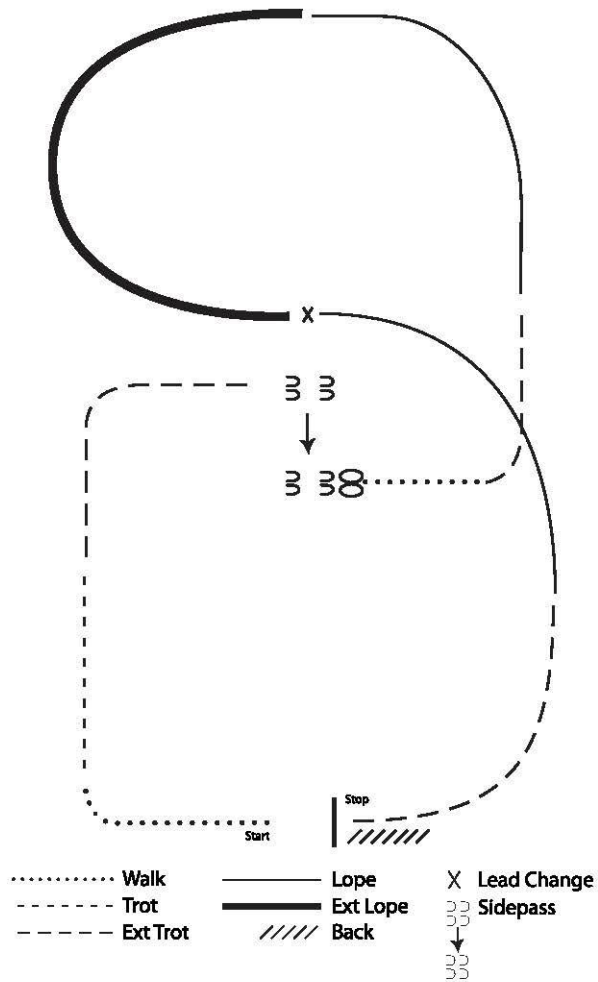

RANCH HORSE RIDING PATTERN 3

1. Walk to the left around corner of the arena
2. Trot
3. Extend alongside of the arena and around the corner to center
4. Stop, side pass right
5. 360 degree turn each direction (either way 1st)
6. Walk
7. Trot
8. Lope left lead
9. Extend the lope
10. Change leads (simple or flying)
11. Collect to the lope
11. Extend Trot
12. Stop and back

Pattern adapted from the Appaloosa Horse Club Ranch Riding Patterns.

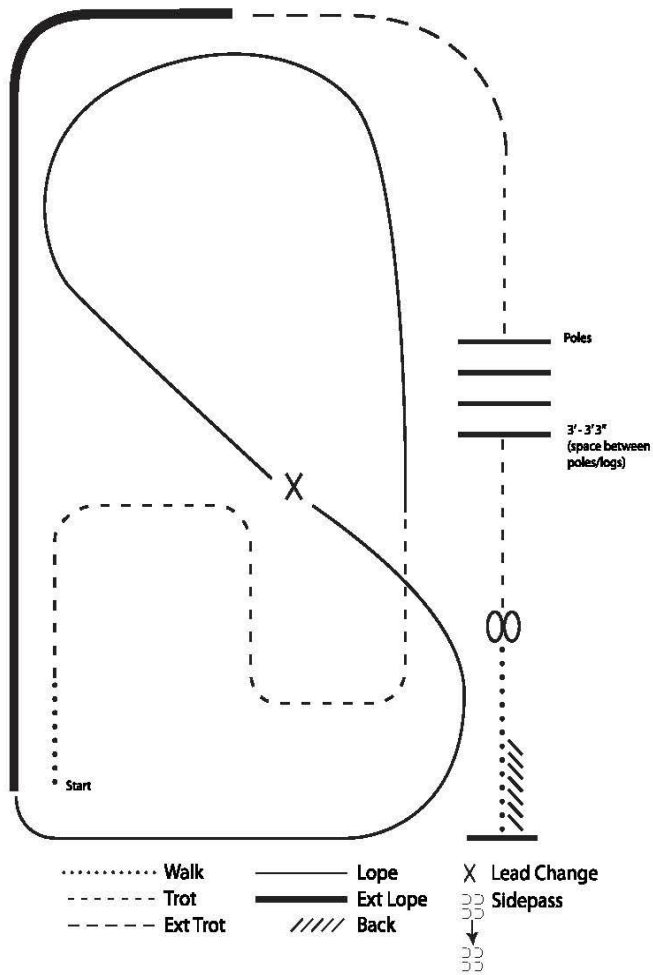

RANCH HORSE RIDING PATTERN 4

1. Walk
2. Trot serpentine
3. Lope left lead around the end of the arena and then diagonally across the arena
4. Change leads (simple or flying) and
5. Lope on the right lead around end of the arena
6. Extend lope on the straight away and around corner to the center of the arena
7. Extend trot around corner of the arena
8. Collect to a trot
9. Trot over poles
10. Stop, do 360 degree turn each direction (either direction 1st) (L-R or R-L)
11. Walk, stop and back

Pattern adapted from the Appaloosa Horse Club Ranch Riding Patterns.

RANCH TRAIL

The ranch trail class should test the horse's ability to cope with situations encountered while being ridden through a pattern of obstacles generally found during the course of everyday ranch work. The horse/rider team is judged on the correctness, efficiency and pattern accuracy with which the obstacles are negotiated and the attitude and mannerisms exhibited by the horse. Judging emphasis is on identifying the well-broke, responsive and well-mannered horse which can navigate and negotiate the course.

Sample Obstacles:

1. Distances for logs: Walk-overs (26-30 in.), Trot-overs (36-42 in.), Lope-overs (6 to 7 feet) no more than five logs or poles no more than 10 inches high. The formation can also be straight, curved, zigzagged, or raised.
2. Opening, passing through, and closing gate: Use a gate that will not endanger horse or rider and requires minimum side passing. Rope gates are acceptable.
3. Ride over wooden bridge: Bridge should be sturdy, safe and negotiated at a walk only. Heavy plywood lying flat on the ground is an acceptable simulation of a bridge. Suggested minimum width shall be 36 inches wide and at least 6 feet long.
4. Backing obstacles: Backing obstacles are to be spaced at a minimum of 34 inches. Back through and around at least three markers. Back through L, V, U, straight or similarly shaped.
5. Side pass obstacle: Any object which is safe and of any length may be used to demonstrate responsiveness of the horse to leg signals. Raised side pass obstacles should not exceed 12 inches.
6. Carry object from one part of the arena to another.
7. Remove and replace materials from mailbox.
8. Trot through cones spaced a minimum of 6 feet apart.
9. Step in and out of obstacle.
10. Put on slicker or coat.
11. Stand to mount with mounting block.
12. Pick up feet.
13. Walk through brush.
14. Ground tie.

Prohibited obstacles: Drag, tarps, water obstacles with slick bottoms, PVC pipe used as a jump or walk over, tires, rocking or moving bridges, logs or poles elevated in a manner that permits such to roll in a dangerous manner.

MISCELLANEOUS CLASSES

ROAD HACK

Appointments

Exhibitors entering classes listed in this division must meet appointment requirements in their respective Division. Exhibitors shall not combine appointments from any division. Martingales are prohibited.

Class Routine

Horses to enter the ring at a trot in a counterclockwise direction until otherwise directed by the judge. To be shown with a **reasonably loose rein** both directions of the ring at a flat-footed walk, trot, extended trot, canter and hand gallop. To stand quietly and back readily. Excessive speed at the hand gallop will be penalized. At the direction of the judge, horses while on the rail may be asked to halt and rein back. Class may be split to hand gallop. Splitting the class for hand galloping will be at the discretion of the event manager and/or judge.

Gaits

1. Walk – flat-footed rapid, elastic
2. Trot – square, collected and balanced
4. Extended trot – balanced, ground covering; ability to extend the forelegs rather than merely increase speed
5. Intermediate gait – a four beat lateral gait, including but not limited to the following gaits: running walk, fox trot and the gaits of the Paso Fino
6. Canter – smooth, collected and straight on both leads
7. Hand gallop – rider collection of the horse's natural running gait, excessive speed will be penalized.

Judging/Scoring

Judged on:

(1) Performance, (2) Manners in that order. The scoring of the equine's performance will be based on the smoothness of the overall performance and especially on the ability to extend the trot by actually lengthening the stride rather than just moving on with more speed.

Disqualifications: See # 14 under General Rules

BRIDLE PATH HACK

Appointments

Exhibitors entering classes listed in this division must meet appointment requirements in their Division. Exhibitors shall not combine appointments from any divisions. Martingales are prohibited.

Class Routine

All horses will upon entering the ring trot in a counterclockwise (if it is a safe area to do so) direction until otherwise directed by the judge. Horses to be shown both directions of the ring at the walk, trot, canter and hand gallop, collected, extended and normal gaits to be called for. To stand quietly and back readily. At the direction of the judge, horses while on the rail may be asked to halt and rein back. Class may be split to hand gallop. Splitting the class for hand galloping will be at the discretion of the event manager and/or judge.

Gaits

1. Walk – flat-footed rapid, elastic
2. Trot – square, collected and balanced

3. Extended trot – balanced, ground covering; ability to extend the forelegs rather than merely increase speed
4. Intermediate gait – a four beat lateral gait, including but not limited to the following gaits: running walk, fox trot and the gaits of the Paso Fino
5. Canter – smooth, collected and straight on both leads
6. Hand gallop – rider collection of the horse's natural running gait, excessive speed will be penalized.

Judging/Scoring

Judged on:

(1) Manners, (2) Performance, in that order

Disqualifications: See # 14 under General Rules

TRAIL CLASS

Trail classes may be handled in three ways:

1. Trail obstacles only.
2. Trail obstacles and performance on the rail.
3. Outside course with suitable obstacles.

Appointments

Attire may be either English or Western, but not a mixture. Attire must be neat, clean, and comply with the rules in the appropriate divisions.

Tack/Equipment

All tack shall be clean, and in serviceable condition. Saddles should fit the horse and rider. Tack used shall comply with the rules in the appropriate divisions.

Class Routine

1. Credit will be given to horses negotiating the obstacles with style and consistency while negotiating obstacles, providing carefulness is not sacrificed, and to horses showing the capability of picking their own way through the course when obstacles warrant it, and willingly responding to rider's cues on more difficult obstacles.
2. Horses with artificial appearance over obstacles shall be penalized.
3. Horses may not be required to work on the rail. However, the course must be designed to require each horse to show the gaits appropriate to their division (walk, trot/jog, canter/lope) somewhere between the obstacles as part of its work and will be scored as a maneuver.
4. A minimum of **6** obstacles will be used. Gaits between obstacles shall be at the discretion of the judge or show management. The course shall be returned to its original design after each horse has worked. Management, when setting a course, should keep in mind that the idea is not to trap a horse or eliminate it by making an obstacle too difficult.
4. Rider may change hands to negotiate obstacles.

Obstacles

Each show committee must plan its course in advance of the show date.

Safety is the major importance.

The judge has the right and duty to alter the course in any manner, to remove any obstacles he deems unsafe before the start of the class. All courses and obstacles are to be constructed with safety in mind so as to eliminate any accidents.

The following list is a guideline for the most common obstacles.

1. *Bridge – Should be sturdy enough to hold the weight of a large horse (1200 lbs or more). The floor should be a solid platform and not more than 12 inches high. The length should be about 8 feet, and width about 4 feet.*
2. *Mailbox – Exhibitor should remove object, show it to the judge and replace object.*
3. *Logs – Approximately 4-6 inches in diameter should be placed on the ground for the horses to walk over.*
 - *Walkovers: 20-24 inches apart.*
 - *Jog or trot overs: 3 feet to 3 feet 6” inches apart.*
 - *Lope or canter over: 6 to 7 feet apart.*
4. *Objects for the riders to carry (such as a raincoat): The riders should be able to pick up the object from a jumping standard, fence post, barrel, etc. and move it to another area of the ring. This cannot be used in walk-trot.*
4. *Backing- (for example, made by lying poles parallel to each other on the ground or elevated by some object. Poles should be at least 6 inches in diameter).*
5. *Cones – Placed so that the horse has to perform a serpentine pattern around them.*
6. *Jump – Should not be less than 12 inches and not more than 18 inches high and should fall on contact. Standard jumps may be used. The course must specify to ride or lead the horse over the jump and at what gait this shall be done. Should not be used in walk-trot.*
7. *Gate*
8. *Side pass*
9. *In the interest of safety, do not ask the rider to drag anything.*

Judging/Scoring

1. Class will be judged on performance, manners, and suitability - in that order, and neatness and cleanliness of horse, tack and rider.
2. Each entry will be allowed a maximum time of 30 seconds or three attempts to pass each obstacle.
3. If the show committee wishes to modify the time allowed for a particular obstacle this must be posted in the course diagram.
4. This class will be judged on the performance of the horse over obstacles, with emphasis on manners, response to the rider, and attitude.
5. Failure to maintain correct gait where specified will be penalized.
6. Course diagram will indicate order of obstacles, paths to be ridden, and gait (walk, trot/jog, canter/lope) to be executed through course to include correct side of markers.

Penalties

Half-Point Penalties

1. Each tick of log pole, cone, or obstacle

1 Point Penalties

1. Each hit or step on obstacle
2. Break of gait at walk or jog 2 strides or less.
3. Both feet in single strided space
4. Split pole in lope-over
5. Skipping or failing to step into required space

3 Point Penalties

1. Break gait at walk or jog over 2 strides
2. Out of lead or break of gait at lope
3. Knocking down an obstacle

5 Point Penalties

1. Drop object
2. 1st refusal, balk or attempt to evade an obstacle more than two strides
3. Loss of control or letting go of gate **or changing hands on gate**
4. Stepping out, falling or jumping off an obstacle with more than one foot

5 or More Point Penalties

1. Blatant disobedience
2. Failure to ever demonstrate correct lead or gait
3. Failure to complete obstacle
4. 2nd refusal, balk or attempt to evade an obstacle more than 2 strides
5. **Freeze up with lack of forward motion for more than 15 seconds**

Overall Disqualifications

1. Rider will be disqualified for taking obstacles out of order
2. Use of more than one finger between the reins
3. Use of two hands except for snaffle or bosal
4. Changing hands on reins except to complete obstacle
5. No attempt to perform an obstacle
6. Equipment failure
7. Touching horse on neck to lower head
8. Use of free hand to instill fear or praise
9. Fall to ground by horse or rider
10. Riding outside course or boundary marker
11. Failure to enter, exit or work obstacle from correct side or direction
12. Incorrect line of travel within or between obstacles
13. 3rd refusal, balk or attempt to evade an obstacle more than 2 strides
14. See #14 under General Rules

COSTUME CLASS

Any type of costume is allowed. Appropriately 4-H themed (meaning no profanity)

Class Routine

Class is walk only both ways of the ring, **either riding or in-hand. Proper footwear required; proper headgear required if mounted. Safety is of major importance.**

Judging/Scoring

Judged 75% on costume (originality, attractiveness and manner presented) and 25% on originality and cleverness, work effort and manners of the horse

Disqualifications: See # 14 under General Rules

COMMAND CLASS

Class Routine

Open to all 4-H'ers and their horses and ponies of any breed or combination of breeds. Divisions may be, but are not limited to, junior and senior riders.

This is an elimination contest where any rider not executing the judge's exact commands promptly and correctly will be eliminated. Delivery of the commands will be at the show committee's discretion and explained to all contestants prior to the start of the class. Individuals may be stationed at various points in the ring to aid in observing and eliminating contestants. The judge may ask contestants to walk, jog or trot, canter or lope, reverse, halt, back, to go from any gait to any other gait and to canter or lope in a counter lead. It is recommended that all judges establish in advance what is to be considered a fault. This class may be divided into sections for English and Western riders, or other divisions if the show management wishes. Tack, appointments, equipment as listed under appropriate division for seat ridden.

Judging/Scoring

Awarding of ribbons is to be based on the order of elimination of final contestants. This is an elimination class. Horses are excused as they fail to follow commands as directed above.

Disqualifications: See # 14 under General Rules

VERSATILITY CLASS

To be judged as a pleasure class with clear difference between English and Western gaits.

Appointments

Tack, appointments, equipment as listed under appropriate division for seat ridden.

Class Routine

To be shown English and Western by the same rider at walk, trot, canter both ways of the ring. The class list should specify which seat to be shown first, changing tack and appointment in the ring. Horses should be asked to back in both seats.

Judging/Scoring

See respective Pleasure Classes.

Disqualifications: See # 14 under General Rules

WESTERN ALL AROUND CLASS

The purpose of this class is to promote the versatility of the 4-H horse that is being ridden western. This is **NOT** strictly an equitation class, pleasure class or halter class but a combination that will showcase the horse that is trail ridden, show pen ridden, gamed or used as a family or lesson mount. This class is not breed specific but is **WESTERN** specific. No registration papers are required for this class.

Tack/Equipment/ Attire

All tack shall be clean, and in serviceable condition. Saddles should fit the horse and rider. Tack used shall comply with the rules in the Western division. Attire shall be as set forth in the Western division.

Class Routine

A true family 4-H horse is easy to handle, quiet, usually easy gaited and does not show undesirable mannerisms. His overall performance should be smooth, consistent and obedient.

1. All horses enter the ring in a counterclockwise direction. All horses will be asked to walk, jog and lope both ways of the ring. Horses will be asked to back. Excessive speed or excessive slowness may be penalized.
2. The first way of the ring, equitation will be the focus. The scoring will be evaluated on the horse's response to the rider including the rider's ability to maintain optimal position and provide maximum performance. This will show the willingness of the horse to work with the rider to obtain peak horsemanship and performance.
3. The second way of the ring, pleasure will be the focus. The scoring will be evaluated on the horse's suitability as a pleasure mount and not necessarily only for the rider performing in the class.
4. Once horses have gone both ways of the ring, they will be asked to come to the center, they will then be stripped of their tack and a halter placed on the horse for a halter line up and review.

Judging/Scoring

Equitation ability: The horse's reaction to the rider's ability to effectively control his/her horse and maintain his/her basic position while doing so. Consideration will be on rider's position, use of aids and cues and control of the horse, and the horse's response to those cues. **To be judged 40% on this portion.**

Pleasure ability: To be judged on manners, and performance and suitability of the horse as a pleasure mount. The smoothness, obedience and consistency of the performance will be considered as well as soundness, way of moving, general balance and patience with the rider. **To be judged 40% on this portion.**

Halter ability: A halter class is defined as a class where the horse is judged based upon its conformation. Selection should be of individuals in the order of their resemblance to the breed ideal represented and that are the most positive combination of balance, structural correctness, and movement with appropriate breed and sex characteristics and adequate muscling. Additionally, the horse and handler pair should be cooperatively working together to best show the horse's desirable halter characteristics. The condition of the horse also is considered. At the discretion of the judge, a horse may be penalized or eliminated from the class "if the horse appears sullen, dull, lethargic, emaciated, drawn or overly tired." **To be judged 20% on this portion.**

Disqualifications: See # 14 under General Rules

4-H HORSE PROJECT CLASS

To be judged 60% on riding ability, suitability of mount to rider and control of mount; and 40% on general knowledge, to be determined by questions from the judge or appointed person. Danish ribbons may be awarded.

Class Routine

To be shown at a walk, trot/jog, canter/lope (depending on division) both ways of the ring and back. Horses may be asked to extend the trot/jog. Each exhibitor will be asked the same questions by the judge.

Disqualifications: See # 14 under General Rules

4-H CLUB CLASS

To be judged on ability to work together, originality, and style of performance.

Special appointments

Costumes and props as needed.

Class Routine

Two or more members of a club will be given 5 minutes in which to complete a program of their choice. Music is optional (show management should designate whether exhibitors should provide their own players, or whether tapes or CD's can only be played, etc.). Time starts as soon as: a) the music begins or b) someone enters the ring. At the end of 5 minutes, time will be called. No cantering/loping permitted. Questions may be asked.

Judging/Scoring

Originality, creativity and workmanship

Disqualifications: See # 14 under General Rules

DISCIPLINED RAIL - HORSE OR PONY

This class is to show the ability of a highly trained equine to perform the requested gait or movement promptly and obediently. Judge shall work the entries adequately but must not overwork them. This is not a game or a fault and out class, and shall not be judged on an elimination basis. Final judging shall be on the basis of the best overall disciplined rail performance including responsiveness, manners, and quality of movements. At all times, the safety of the horses and exhibitors is to be the first concern.

Tack, Equipment and Appointments

Refer to New England 4-H Horse Show Rules and Guidelines for the appropriate seat.

Class Routine

The class routine shall be to perform work on the rail, and may include, but is not limited to:

- a. Starting and traveling on the outside lead.*
- b. Side pass both away from the rail (at least five steps) and then back to the rail.*
- c. Turn on forehand and turn on hindquarter (once each way).*
- d. Stop and stand quietly on a loose rein.*
- e. Judge may ask for a reverse at the trot/jog but not at the canter/lope.*
- f. Judge may ask for additional safe work.*

Judging/Scoring

To be judged on performance, smoothness, obedience and consistency.

Disqualifications: See # 14 under General Rules

DRIVING DIVISION

PERSONAL ATTIRE AND APPOINTMENTS

A. Required

1. Approved protective helmet
2. Riding boots with distinguishable heel
3. Gloves- required for carriage driving, optional for show type driving
4. Female - skirt and blouse, dress, or dress slacks and blouse. Shoulders must be covered and no plunging neck lines.
5. Male - shirt, tie and dress slacks.

B. Optional

1. Jacket
2. Lap Robe/Apron
3. Any protective safety equipment for the rider (protective vest, other)

C. Prohibited

1. Period costumes
2. T-shirts, sweatshirts, tank tops or crew neck shirts
3. Open-toed shoes, sandals, sneakers, clogs, shoes or boots with heels greater than 2"
4. Spurs

TACK AND EQUIPMENT

A. Required

1. Appropriate 2 or 4 wheeled vehicle, stable and in good repair
2. Standard bridle with blinkers/blinders
3. Snaffle or driving bit (i.e., Liverpool or Buxton) Bits may be covered with rubber or leather.
4. Whip, must be able to touch the back pad of the harness while the driver is seated. Lash shall not go past the point of the shoulder.
5. Driving harness
6. Pinky loop is required if the reins fall out or between the floorboards or basket of cart.

B. Optional

1. Driving martingales
2. Over or Side Check
3. Breeching or Thimbles

C. Prohibited

1. Racing sulkies and chariots
2. Quarter boots
3. Twisted wire or wire bits
4. Draw reins, side reins, chambon, nose reins, gogue and other similar training devices.

PLEASE NOTE: This does not include the use of over check or side check.

D. Allowed in practice and warm-up rings

1. Same as show ring

E. Specifications

1. Vehicle - Any appropriate 2 or 4 wheeled vehicles is acceptable as long as it is of good repair and stability. It is the responsibility of each competitor to ensure that harness and vehicle are in good repair and structurally sound.

2. Harness - There shall be no restrictions on the type of harness used as long as it is appropriate for the type of equine and vehicle used. Lines may be placed under the shoulder strap going to the breast collar.

GENERAL SPECIFICATIONS

A. Entries to be shown to a suitable 2 or 4 wheeled vehicles with an appropriate harness. Required gaits shall be the walk/ flat walk, working trot/pleasure trot, and extended trot/road trot. When asked to extend the trot, entries should show both speed and form. The pleasure driving equine should be light mouthed and capable of being taken up at any time, willing to walk and stand quietly and to back easily and readily. All drivers (Jr. or Sr.) may have an adult passenger at their option.

The adult passenger would be a knowledgeable adult, who is over 18 years of age. Any 4-Her 13 and under is recommended to have experienced adult passenger. Excluding mini based on size limitations. The accompanying adult may dismount and serve as a header but shall render no other assistance except in an emergency. No pets shall be allowed in the cart. Any communication with or attempt by the adult to influence the exhibitor in any way except in an emergency situation shall be cause for dismissal and disqualification of the entry at the discretion of the judge.

B. Headers MUST be called into the ring when horses are called to line up. If drivers are to stand for an extended amount of time headers are required. Headers MUST have working experience with driving animals. Headers ARE REQUIRED at any 4-H sanctioned show.

C. Outside assistance (such as coaching from the rail) in any class after the judging has begun entails disqualification unless the safety of the exhibitors and horses are at risk.

D. All classes shall be for a single hitched equine (no teams or tandem hitches).

E. Equines should never be left unattended while put to a vehicle. Failure to observe this rule shall cause immediate elimination.

F. Under no condition is a bridle to be removed from an equine while it is still put to a vehicle. If this occurs, it is an automatic elimination.

G. A driver who leaves his or her cart; except at the judge's direction; shall be eliminated. At the judge's discretion the contestant may be permitted to complete the class, but not place.

H. It is obvious that, however complete rules may be, they never can cover all possible situations which may arise. If a matter cannot be solved by interpreting the rules to the letter, the solution to be adopted by the show management should lie in a principle which follows as nearly as possible the spirit of the rules.

I. *A Technical Delegate/4-H Show Steward conversant with the 4-H Driving Division rules shall be present at all 4-H driving competitions. A Technical Delegate/4-H Show Steward (TD/SS) has no authority in connection with the judging of an event except as specifically noted. The TD/SS shall point out in a diplomatic manner any instance where 4-H rules and directives are not enforced and shall have the authority to eliminate from that class and from the show, entries that fail to comply. The TD/SS should not dictate to judges or management but should immediately report to the appropriate officials any violations of the rules which might invalidate a class or induce disciplinary action. The TD/SS should be*

made available to judges, exhibitors, and management at all times to clarify the application of 4-H rules and investigate any situation in which the rules are not upheld.

J. Each exhibitor is responsible to present themselves and their turnout to the TD/SS at least 5 minutes prior to the start of each class for safety check of all tack, equipment and appointments. Failure to meet requirements shall result in immediate elimination by the TD/SS.

K. If during a class any breakage occurs to the cart or harness, the exhibitor will be granted a two-minute time out, if not repaired in the time out disqualification occurs.

L. Exhibitors must have whip in hand OR in a whip holder. Whip holder must be placed so that the driver must not reach over his or her lines to pick up the whip.

CLARIFICATION OF GAITS - The following descriptions constitute the approved standard for performance of each of the recommended gaits in the various divisions of a pleasure driving competition. All gaits will be appropriate for breed standards.

A. Walk - A free, regular, flat-footed unconstrained walk of moderate length is required. The equine should walk energetically but calmly, with 4 even and determined steps.

B. Pleasure trot - The equine should go forward freely and straight, engaging the hind legs with good hock action, on a taut but light rein, the position being balanced and unconstrained. The steps should be as even as possible. The hind feet touch the ground in the footprints of the fore feet. The degree of energy and impulsion displayed at the working trot denotes clearly the suppleness and balance of the equine.

C. Extended trot - Clear but not excessive increase in pace and lengthening of stride while remaining well balanced and showing appropriate lateral flexion on turns; light contact to be maintained. Excessive speed shall be penalized.

D. Halt – Equine and vehicle should be brought to a complete square stop without abruptness or veering. At the halt, the equine should stand attentive, motionless and straight, with the weight evenly distributed over all four legs, and be ready to move off at the slightest indication from the driver.

E. Rein back - This is backwards movement in which the legs are raised and set down simultaneously in diagonal pairs with the hind legs remaining well in line. To be performed in two parts: 1) rein back at least four steps, unhurried; with head flexed and straight, pushing back evenly in a straight line using light contact and quiet aids; and 2) move forward willingly to the former position using the same quiet aids. Horse is not to be penalized if it steps forward a step or two prior to backing.

DRIVING CLASSES

REINSMANSHIP

Class Procedure:

1. All contestants to enter the ring tracking right at the walk until otherwise directed by the judge.
2. Equines will be shown both ways of the arena at a walk, working trot, and extended trot. Drivers shall be required to rein back.
3. All drivers will be asked to perform a workout and must be worked both ways of the arena at any gait requested by the judge and may be asked to execute a figure 8 and perform any other appropriate tests.

Reinsmanship Tests may include:

- Back four (4) steps and return to place in line.
- Drive a circle—size at judge's direction.
- Drive a figure-eight.
- Drive at an extended trot/increased intermediate gait.
- Negotiate a simple obstacle (i.e., drive between two (2) obstacles at a working trot or halt between two (2) given markers).
- Pivot (turn) with one wheel in place, left or right, at 90°, 180°, or 360°, at judge's direction.
- Back between two (2) markers.
- Drive at the extended flat-footed walk.

Basis of Judging:

Judged as an equitation class on hands, proper harnessing, hitching, and correct driving techniques.

Driver should be able to change gaits quickly, smoothly, and unobtrusively while always maintaining contact and using correct driving techniques.

90% on handling of reins and whip, control, posture, and overall appearance of the driver.

10% on proper harnessing and hitching, condition of harness and vehicle, and neatness of attire.

Disqualifications: See # 14 under General Rules, this applies to all Driving classes

PLEASURE DRIVING

Class Procedure:

1. All contestants to enter the ring tracking right at the walk until otherwise directed by the judge. They shall then be required to perform at each of the required gaits. They shall then be reversed at the walk or working trot and required to repeat the same procedure in that direction. It is suggested that the reverse be done by turning toward the center of the ring and then crossing diagonally to the other side of the ring, proceeding in the opposite direction.

2. After completing the procedure above, the judge shall ask exhibitors to line up, to rein back individually at the judge's command, and to stand quietly.

3. Equines should be shown on the rail at all times except when passing and should go to the far end of every corner without side reining.

4. The driver shall not leave his vehicle without permission of the ring master, then only for necessary adjustments to harness. Judging and Scoring In scoring, emphasis shall be placed on the suitability of the entry for pleasure driving rather than for use of the roadster or fine harness equine. Scoring to be based 90% on performance and manners, 10% on appointments.

Basis of Judging:

The pleasure driving horse should have basically the same general qualities as the pleasure saddle horse. Special emphasis is placed on the flat-footed walk and the pleasurability of the ride for the driver. The horse should be in balance with a head and neck carriage typical of its breed or type, should be light-mouthed, and have a free way of moving. At all gaits, it must work in form (i.e., head held quietly, mouth closed, and legs working beneath itself). The traces should be steady at all times, demonstrating consistency of forward motion and that the horse is pulling from the traces, not from the mouth or saddle. Erratic movements are highly undesirable. Hesitation or breaking stride will be penalized

Disqualifications: See # 14 under General Rules, this applies to all Driving classes

PRECISION DRIVING

Class Procedure:

This competition tests the skill of the driver, the obedience and handiness of the animal, and the accuracy with which the course is driven.

Faults:

First and second refusal, displacing marker, hoof and wheel outside marker, and breaking gait.

Elimination:

Three (3) accumulated refusals, receiving outside assistance, showing an obstacle to the horse, taking an obstacle out of order (off course).

Judging :

Based on performance, manner, and appropriateness of entry.

Competitors will be required to drive over a course consisting of six (6) to eight (8) obstacles (see Figure 3). The course will be irregular, necessitating changes of direction. Markers indicating obstacles will be at least 12 inches wider than the outside hub of the wheels of each vehicle. Markers indicating obstacles will be at least 12 inches high. (Traffic cones with tennis balls on top work well—see Figure 4). *Lanes may be defined by rails at least three (3) inches in diameter*

Basis of Judging:

The purpose of the competition is to test the skill of the driver and the obedience and handiness of the animal.

80% on the fault system

20% on manners and smoothness of performance

Disqualifications: See # 14 under General Rules, this applies to all Driving classes

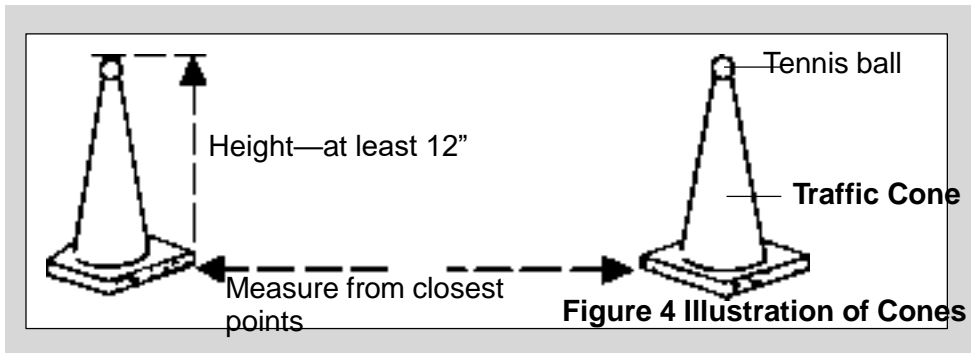
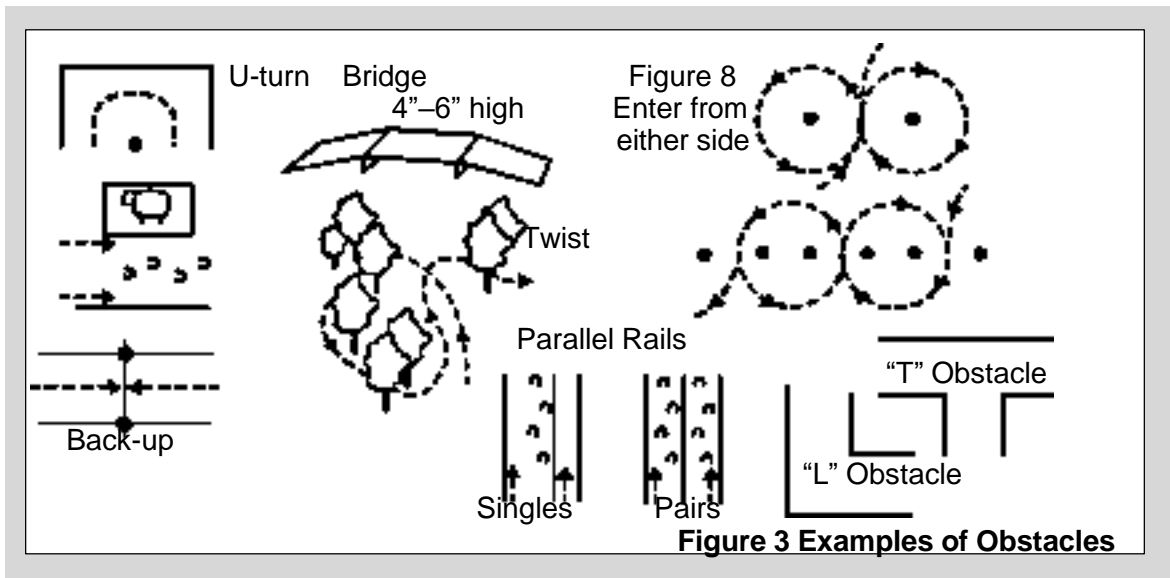

COURSES

Course #1: (see Figure 1)

- (1) Enter at a trot
- (2) Trot through 10-foot square (four [4] cones)
- (3) Trot a serpentine of four (4) cones (25' apart)
- (4) Walk with right wheel(s) between poles (6"-8" apart)
- (5) (A) (B) Trot a figure-eight
- (6) Walk with left wheel(s) between poles
- (7) Walk a serpentine
- (8) Walk into square, stop with wheels (front) between front cones, back four (4) steps, return to forward position
- (9) Stand quietly until dismissed by judge or ringmaster

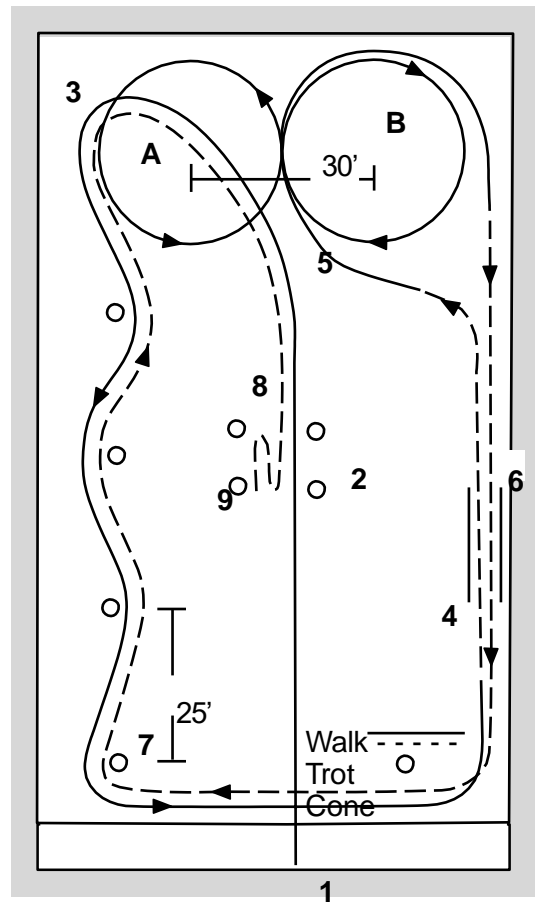

Figure 1 Precision Driving
Standard Course #1

Course #2: (see Figure 2)

- (1) Enter at a trot
- (2) Trot through two (2) pairs of cones (10' square, CDEF)
- (3) Trot a figure-eight (go to the left cone first)
- (4) Trot a serpentine of five (5) cones (25' apart)
- (5) Walk with right wheel(s) between poles (6"-8" apart)
- (6) Walk to top of four (4) cone square (CDEF) pivot 90 degrees to the right, back to the farthest set of cones (EF), stand ten (10) seconds, trot out of square
- (7) Trot with left wheel(s) between poles and exit

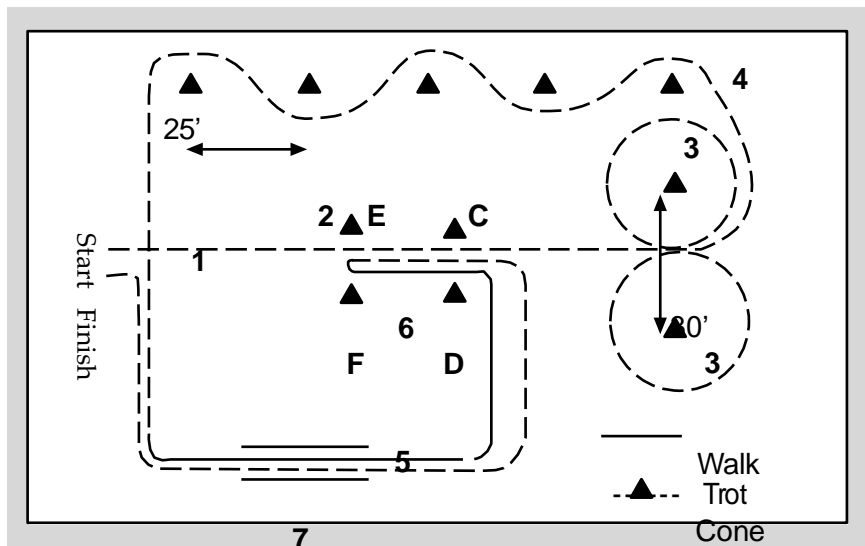

Figure 2 Precision Driving, Standard Course #2

OBSTACLE DRIVING

All Equines - Not timed, and to be judged similar to an In-Hand Obstacle/Trail class

Class Procedure:

1. General course requirements shall include the following:
 - a. All obstacles driven over a prescribed course.
 - b. The maximum width of "L" and "U" shaped obstacles shall be 10' and 13', respectively, for large equines; 8' and 10', respectively, for small equines.
 - c. While many devices prove useful as obstacle markers, the "traffic cones" are the most easily obtained and quickly set.
 - d. Competitors are prohibited from driving, leading, or riding their equines on any course at any time prior to the competition. It is advisable, however, for competitors to walk the course prior to the competition.
 - e. Equines must be three years old for obstacle driving
 - f. All obstacles must be numbered on the course in order of sequence

Basis of Judging:

1 Point Penalties

1. Knocking over start or finish marker
2. Knocking down or dislodging obstacle
3. First disobedience*
4. First break from trot to canter
5. Each hoof outside marker
6. Wheel outside marker

2 Point Penalties

1. Second disobedience*
2. Second break from trot to canter

3 Point Penalties

1. Not completing an obstacle
2. 60 second time limit exceeded per obstacle – ask to move to next obstacle

0 Score on an obstacle

1. 3 refusals at one obstacle results in a zero score – ask to move to next obstacle

Elimination

1. Starting before signal
2. Failure to cross starting line w/in 1 min.
3. Failure to cross starting or finish line
4. Going off course (taking obstacles out of order)
5. Outside assistance
6. Failure to carry a whip
7. Breakage of harness or vehicle
8. Prolonged canter
9. The following is considered off course and shall result in elimination from the class:
 - Taking obstacle from wrong side
 - Skipping obstacle unless directed by judge
 - Attendants interfering with the performance of exhibitor

* **Disobediences** include:

- a. Run-out - evading or passing an obstacle or the finish line.
- b. Refusal - stopping for a prolonged time in front of an obstacle or stopping and then backing (even one step) in front of an obstacle. It is not considered a refusal if the equine stops and then immediately proceeds forward.
- c. Any form of circle which causes a competitor to cross the original track between two consecutive obstacles, except to retake an obstacle after a refusal or run-out shall be penalized.

In the event of a tie, there will be a drive-off over a shortened course

Disqualifications: See # 14 under General Rules, this applies to all Driving classes

COMBINATION CLASS

Drive and Ride, All Equines - Junior/Senior

The personal appointments of all contestants entered in these classes shall, in addition to those specified for driving, also correspond to those personal appointments specified for the equitation class of the appropriate seat

Class Routine

1. To be shown in two sections:
 - a. In harness - to be shown to a suitable pleasure driving vehicle, both ways of the arena at a walk, pleasure trot, and extended trot. To stand quietly and to rein back.
 - b. Under saddle - to be shown both ways of the arena at a walk, trot or jog, and canter or lope. To stand quietly and to rein back.
2. Class routine shall include the following specifics:
 - a. In combination classes, each entry must be shown by the same person in all sections.
 - b. Two grooms or attendants may assist with unharnessing but shall not enter the ring until directed to do so.
 - c. **Removal of the bridle while an equine is put to a vehicle calls for automatic elimination.**
 - d. The vehicles are to be removed from the arena as soon as the unharnessing is completed.

Judging and Scoring

- 50% on performance, manners, way of going, and suitability in harness
- 50% on performance, manners and way of going under saddle.

Disqualifications: See # 14 under General Rules, this applies to all Driving classes

TIMED DRIVING GAMES

General Rules

- Appointments: Same as Driving Performance Classes.
- Harness and Vehicle: Same as Driving Performance Classes.
- Contestant's number must be clearly visible at all times on his or her back.
- Events will be timed on individual runs; awards will be given to those with the lowest (fastest) times.
- Contestants must enter and leave the arena at a walk or slow trot.
- Horse or pony must be under control of driver at all times.
- Driver must start course within one (1) minute of being given the starting signal.
- In case of a tie, the drivers may flip a coin or accept a tie-off. In breaking a tie, the loser takes the next lower position.
- In the event of a timer failure, a contestant with a clean ride (no disqualifications) will be entitled to a re-run and the time obtained will be used plus any penalties occurring in the re-run.
- In the event of interference, a re-drive, if requested by the driver, shall be at the discretion of the judge. All re-drives will be made after the last driver in the class has completed the course.
- Only contestants, ring crew, and officials are allowed in the arena.
- During the running of any event, all arena gates must be closed.
- In all events, two (2) poles thirty (30) feet apart shall designate the start–finish line. A horse must pass between these poles at the start and finish or be considered off course.
- Markers may be poles, barrels, or traffic cones. All markers must be at least 12 inches high.
- In all events, the ring crew will reset downed equipment only after the competitor has completed the course.

Penalties

There shall be a five- (5) second penalty assessed for each of the following:

- Knockdown of a marker.
- Break from a trot.

Disqualifications

- Off course—failure to complete the course as diagrammed.
- Refusals.
- Upsetting the start-finish poles.
- Stopping the timer before completion of course by any portion of horse or cart.
- Failure to start within one (1) minute of the starting signal.
- Unsportsmanlike conduct (use of profane language; unnecessary roughness and abuse of horse; disorderly conduct of any kind).
- A horse deemed out of control or unmanageable by a judge may be disqualified from the event and the entire show with no refund of entry fee.
- Upset of vehicle (if side of vehicle touches ground).
- See # 14 under General Rules, this applies to all Driving classes

EVENTS

Driving Barrel Race (see Figure 5)

Course: Three (3) markers placed in triangular formation 75 feet apart with first and second Markers placed 30 feet out from the start-finish line (see Figure 5). (Alternate course for narrow arena: first and second markers 33 feet out from start-finish line and 60 feet apart; third marker 30 feet from first and second markers.)

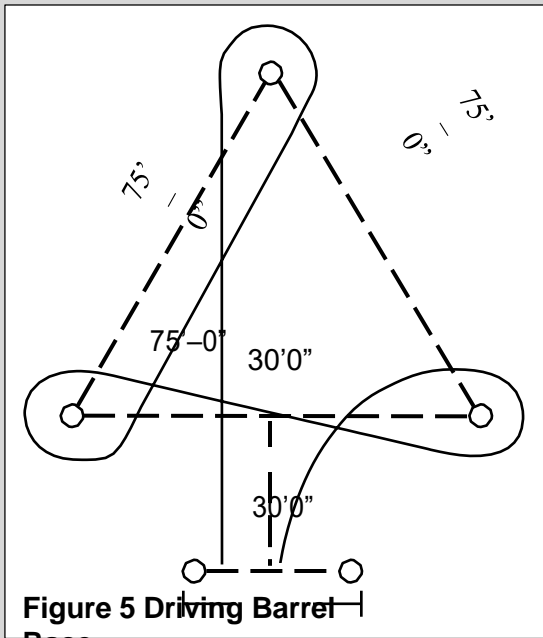

Figure 5 Driving Barrel Race

Pattern: Course may be driven to the right or to the left.

- *Right:* Driver crosses start-finish line, circles #1 marker to right, crosses to #2 marker, circles it to left, drives to #3 marker, circles it to left and returns across start-finish line.
- *Left:* Driver crosses start-finish line, circles #2 marker to left, crosses to #1 marker, circles it to right, drives to #3 marker, circles it to right and returns across start-finish line.

Driving Pole Bending Race (see Figure 6)

Course: Six (6) markers placed in a straight line, spaced 25 feet apart with the start-finish line 25 feet in front of the first marker (see Figure 6).

Pattern: May be driven in either direction. Driver crosses start-finish line, drives down the right or left side of markers; turns around #6 marker and weaves in and out of the line of markers; turns around #1 marker and weaves in and out of the line of markers again; turns around #6 marker and drives across the start-finish line.

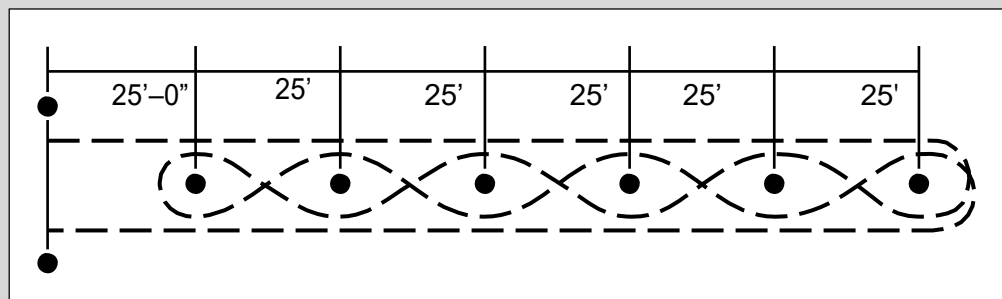
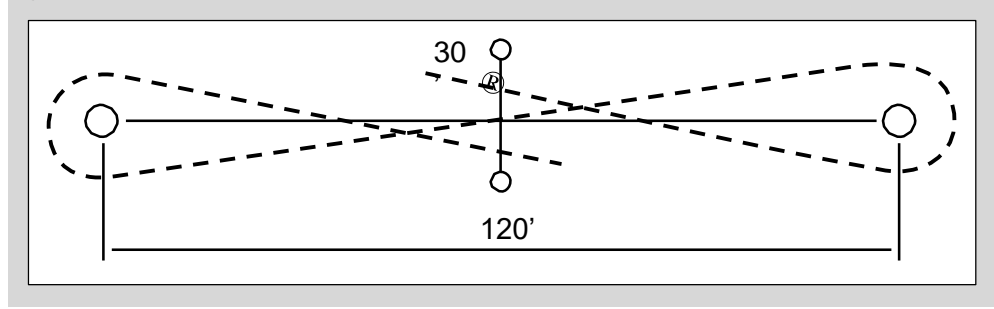

Figure 6 Driving Pole Bending Race

Driving Figure-Eight Stake Race (see Figure 7)

Course: Two (2) markers placed 120 feet apart with the start–finish line an equal distance (60 feet) between (see Figure 7).

Pattern: Driver may begin in either direction; turns around first marker, recrosses start–finish line, turns around second marker in opposite direction and completes the “8” pattern by passing over



the start-finish line.

Figure 7 Driving Figure Eight Stake Race

Driving Idaho Figure Eight (see Figure 8)

Course: Two (2) markers placed 100 feet apart with the first marker 20 feet from the start–finish line (see Figure 8).

Pattern: May be driven in either direction; driver crosses start–finish line, drives down the right or left side of markers, turns around #2 marker, crosses between the markers, turns around #1 marker, continues back to #2 marker in “8” pattern, turns around #2 marker and returns across start–finish line.

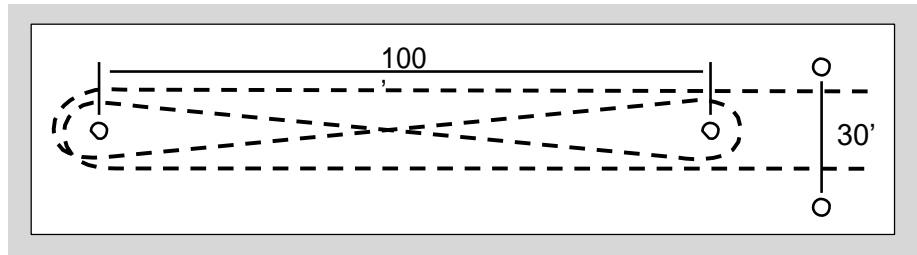

Figure 8 Driving Idaho Figure Eight

Driving Key Race (see Figure 9)

Course: Four (4) markers: #1 set to be 100 feet from the start–finish line, #2 set to be ten (10) feet beyond the first set, and at least 25 feet from the end of the arena (see Figure 9). In each set the markers are to be at least five (5) feet apart (at least two [2] feet wider than the outside hub of the wheels of the largest vehicle). (2'–10' poles may be substituted for the four [4] markers.)

Pattern: The driver crosses start–finish line, drives between markers beyond #2 set, turns in either direction, drives back between markers, and across start–finish line.

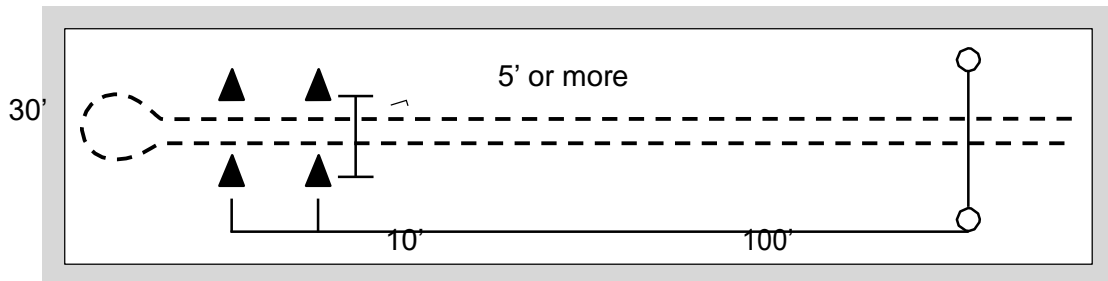

Figure 9. Driving Key Race

GAMBLER'S CHOICE – All Equines

Class Routine

1. Each driver has the same amount of time in which to negotiate as many obstacles as possible. Each obstacle is assigned a point value according to its degree of difficulty, the easier obstacles having a lesser value than the more difficult obstacles and each driver tries to obtain as high a point score as possible in the time allowed.
 - a. Obstacles may be driven in any order.
 - b. Each obstacle can be attempted twice and may be approached from either direction.
 - c. Drivers must attempt a different obstacle before returning to that obstacle for a second try.
 - d. Once an obstacle has been disrupted, it can no longer be attempted.
2. **If all obstacles are completed twice before the two-minute time limit**, the driver will exit through the finish line for the final point and time scoring.
3. A signal will show the end of two minutes, after the signal, the driver must exit through the finish line. At that point the total time on the course will be recorded. Time allowed must be stated.
4. In the case of a driver being committed to or in the process of negotiating an obstacle and if clean, will be awarded the points for that obstacle. Having completed the obstacle, the driver must proceed through the finish line for the total time on course to be recorded. Whether or not the driver was committed to the next obstacle at signal will be left to the discretion of the presiding official. No score will be awarded for an incorrectly completed obstacle.
5. In the event of equality of points, the fastest time recorded is the winner. If both of these are equal; the winner will be determined by a drive-off.

10 Second Penalties

1. Knocking over start or finish marker
2. First disobedience
3. Second disobedience
4. First break to canter

20 Second Penalties

1. Second break to canter

Elimination

1. Third disobedience
2. Starting before signal
3. Failure to cross starting line within 1 minute
4. Failure to cross starting or finish line
5. Outside assistance
6. Failure to carry a whip
7. Breakage of harness or vehicle
8. Third break or prolonged canter

DRIVING ALL AROUND

The purpose of this class is to show the versatility of the 4-H horse that is being driven. This is **NOT** strictly a reinsmanship, pleasure or halter class but a combination that will showcase the horse that is trail driven, show pen driven, or used as a family or lesson equine. This class is not breed specific but is **DRIVING** specific. No registration papers are required for this class.

Judged 40% reinsmanship, 40% for pleasure driving and 20% on halter conformation.

Tack/Equipment/ Attire

All tack shall be clean, and in serviceable condition. Harness and vehicle should fit the horse and driver. Tack used shall comply with the rules in the Driving division. Attire shall be as set forth in the Driving division.

Class Routine

A true family 4-H horse is easy to handle, quiet, usually easy gaited and does not show undesirable mannerisms. His overall performance should be smooth, consistent and obedient.

1. All horses enter the ring in a counterclockwise direction. All horses will be asked to walk, pleasure trot, extend the trot and halt. Horses will be asked to rein back.
2. The first way of the ring, reinsmanship will be the focus. The scoring will be evaluated on the horse's response to the driver including the driver's ability to maintain optimal position and provide maximum performance. This will show the willingness of the horse to work with the driver to obtain peak reinsmanship and performance.
3. The second way of the ring, pleasure driving will be the focus. The scoring will be evaluated on the horse's suitability as a pleasure driving horse.
4. Once horses have gone both ways of the ring, they will be asked to come to the center, they will then be stripped of their tack and a halter placed on the horse for a halter line up and review.

Judging/Scoring

Reinsmanship ability: The horse's reaction to the rider's ability to effectively control his/her horse and maintain his/her basic position while doing so. **To be judged 40% on this portion.**

Pleasure driving ability: To be judged on manners, and performance and suitability as a pleasure driving horse, obedience and consistency of the performance will be considered as well as soundness, way of moving, general balance and patience with the driver. **To be judged 40% on this portion.**

Halter ability: A halter class is defined as a class where the horse is judged based upon its conformation. Selection should be of individuals in the order of their resemblance to the breed ideal represented and that are the most positive combination of balance, structural correctness, and movement with appropriate breed and sex characteristics and adequate muscling. Additionally, the horse and handler pair should be cooperatively working together to best show the horse's desirable halter characteristics. The condition of the horse also is considered. At the discretion of the judge, a horse may be penalized or eliminated from the class "if the horse appears sullen, dull, lethargic, emaciated, drawn or overly tired." **To be judged 20% on this portion.**

Disqualifications: See # 14 under General Rules, this applies to all Driving classes

DISCIPLINED RAIL DRIVING - HORSE, PONY OR MINIATURE

General

This class is to show the ability of a highly trained equine. To be shown in a two- wheeled cart. Judge shall work the entries adequately but must not overwork the entries. This is not a game or a fault-and-out class and shall not be judged on an elimination basis.

Scoring

Judging shall be on the basis of the best overall disciplined rail performance. To be judged on performance, smoothness, obedience and consistency.

Procedure

This class routine shall be to perform work on the rail and will include, but not be limited to:

- a. A flat-footed walk.
- b. Pleasure trot.
- c. Extended trot (not to exceed twice around the ring).
- d. Starting with a flat-footed walk, through a pleasure trot to an extended trot.
- e. Stand quietly.
- f. Pivot (Pivot to side pass as though there were a wall in front and behind with one-wheel rolling). Pivot not to exceed 90 degrees. Judge may ask for both right and left or either.)
- g. Back four (4) steps.

Disqualifications: See # 14 under General Rules, this applies to all Driving classes

Unsafe equipment, unruly behavior of the horse or driver or excessive use of the whip will be grounds for disqualification.

Additional driving events may be adapted as long as they follow standard rules.

PROPER HARNESS TERMINOLOGY

Reins - Usually buckled onto the bit. Reins that snap to the bit may break, fall apart, or catch on something else. Reins should pass through the terrets and have a buckle or swivel coupler for connecting the hand piece ends. The reins for both black and brown harness may be all brown or black from bit to rump and brown to connecting buckle. (Amish harness may have all black reins.)

Check Reins

Overhead Check Rein (Overcheck). Standard on Amish-type harness and in some breed divisions. It is a Y strap fastened to the driving snaffle or separate bridoon (check bit); it passes between the ears, through a keeper on the crown piece and attaches to the check hook on the top of the back pad or saddle.

Sidecheck Rein. Attaches to the top of the bit ring or check bit, then runs on either side of the head through rings connected to the crown piece at about eye level and on to the check hook on the back pad or saddle.

Breast Collar - Should lie at the base of the neck around the chest. It is adjusted for elevation by the neck strap.

Traces - May buckle to the breast collar or be a continuation of the breast collar. Traces should lie in line with the shafts. The trace ends fasten to the single tree (which pivots at its center to allow the free movement of the shoulders to be absorbed and to become forward motion) or to the shaft trace hooks.

Shaft Loops - Are buckled to each side of the saddle; they adjust the height of the shafts.

Saddle or Back pad - placed four (4) to eight (8) inches behind the withers. It is held in place by the girth and by the backstrap. The girth should be snug, but not as tight as a regular saddle cinch. The backstrap should be adjusted so that the crupper hangs about 1/2 inch below the dock.

Wrap Straps (Safety Straps) Attached to the girth by a keeper; they secure the shaft loops to the shafts. This usually is the position where the shafts curve closest to the body of the horse. The shafts may be covered with leather or have shaft stops attached to the shafts at this place. This arrangement may take the place of breeching on light show buggies or carts over level surfaces.

Breeching (Optional)

There are two main types of breeching in use:

- Breeching is hung from a quarter strap that passes through a loop on the back strap. The holdback strap is buckled around a "D" attached to the shaft. The horizontal breeching strap should rest where the hip curves into the leg. It should lay against the horse, neither floppy nor tight. The horse must be able to move freely at the trot on.

Kicking Strap (Optional) Used on single harness as a safety measure should a horse be inclined to kick in harness. It is also a safety measure with green horses. It is a long strap buckled to each shaft and passed through a loop on the backstrap over the croup of the horse.

Running Martingale May be used with an overcheck and snaffle bit. Adjust it so that the reins are in a straight line from the bit, through the rings of the martingale to the terrets. Do not use with side checks unless for safety reasons.

Driver's Position

The driver's position on the seat must be secure, but not so stiff that any sudden movement will cause a loss of balance. Sit up straight with the arms slightly extended, elbows slightly bent and close to the body. Look ahead between the ears of the horse. Hold the reins with a light hand, keeping constant contact with the horse's mouth. Adjust the seat and foot board to allow the knees to be comfortably bent. The feet should be just far enough apart to maintain balance—one foot slightly ahead of the other rather than spread apart. The whip is held at the point of balance, resting on the forefinger and lightly in the palm of the hand by the lower three fingers.

Hands - Driving with either one or both hands is optional and neither is given preference.

Driving with Two Hands

There are three options for holding the reins.

Option 1: Reins held between thumb and index (first) finger.

Option 2: Reins held between index (first) finger and middle (second) finger.

Option 3: Reins go under little finger OR between ring (third) and little (fourth) finger, come out between index (first) and middle (second) fingers, then between index finger and thumb and down through fist. This position offers the most control. *Hands* are held close together with the bight (buckle) of the reins held by the little finger. Holding this loop by the little finger of the left hand allows the left hand to control the reins and the right hand to control the whip. A rein loop added to the buckle (i.e., shoelace section) to put over the little finger is easier on small hands than holding the bight of the reins.

Whip is held in the right hand at a 45° angle to the horse.

Turning

Turns may be made by rotating the left hand and a slight movement across the body to the left or right, by taking a loop, or by using the right hand.

Turning Left by Taking a Loop

Right hand holds the left rein with the second, third, and little fingers. The right hand is in front of the left hand approximately six inches (depending on the sharpness of the turn). Bring the right hand back so that therein forms a loop under the left thumb, which presses firmly down to hold the loop in position. The left hand is not moved forward as the loop is taken. Thumb releases loop when turn is completed. The left hand should be about seven inches in front of the center of the body, with the thumb pointed across the body, index finger extended, pointed slightly downward and to the rear. The near rein passes between the thumb and index finger. The off-side (right) rein passes between the second and the third fingers. Both reins are held firmly in the palm of the hand by the lower three fingers. The thumb is not pressed down on the rein except when a loop is taken up to turn a corner. The right hand, with the whip in palm, should always be ready to make any needed adjustment. The whip is held with the top well up, pointed across the body toward the horse's left ear.

Turning Right by Taking a Loop

Right hand takes hold of the right rein in exactly the same manner as above for turning left. The rein is held firmly under the left thumb until the turn is completed when the rein is released

Turning Left by Using the Right Hand

The right hand is placed on the left rein slightly in front of the left hand. The rein is held lightly downward, and backward pressure is put on the left rein. The horse will then turn left. The right hand is removed from the rein as soon as the turn is completed.

Turning Right by Using the Right Hand

To turn right, use the same procedure as above, with the right-hand putting light pressure on the right rein, releasing it as soon as the turn is completed.

Shortening the Reins

The right hand takes hold of both reins in front of the left hand: right rein between the ring and the little finger; left rein between the first and second fingers. The fingers of the left hand are relaxed to allow the reins to be pushed back between them by the right hand. When reins are shortened sufficiently, the fingers of the left hand are closed on the reins again and the right hand is released. Using this method, contact with the horse's mouth is not lost.

- The harness and vehicle must be in good repair and structurally sound.

Always bridle the horse before hitching him or her to the vehicle and attach the reins immediately.

- Always have the horse held while putting to a vehicle. If you must hitch alone, keep reins in one hand while you control the shafts with the other. Never back an animal between shafts that are on the ground.
- Never hitch or unhitch in unfamiliar surroundings without a capable person at the animal's head.
- **Never** leave the driver's reins unbuckled in case one rein drops while mounting or driving.
- **Never** allow passengers to enter a vehicle until you are seated with reins in hand and never dismount while passengers are in the vehicle.
- Drivers must remain a safe distance from other vehicles, especially in passing and lining up at the completion of work in a class.
- Ensure that your horse is physically fit to perform the tasks required.
- Always have shafts the proper length for the animal. There must be adequate room for the animal's hind legs to move freely at an extended trot and still have the shaft's tips at the point of the animal's shoulder.

SMALL EQUINE DIVISION

Personal attire and appointments

A. Required

1. Approved protective helmet (ASTM/SEI) required by all occupants when in a hitched vehicle or involved in a timed event
2. Riding boots with distinguishable heel (except in Hunters, Jumpers, and Gymkhana where type of footwear is optional)

B. Prohibited

1. Period costumes
2. T-shirts, sweatshirts, tank tops or crew neck shirts
3. Open-toed shoes, sandals, clogs, shoes or boots with heels higher than 2"
4. Clip on spurs
5. In halter obstacle, hunters, jumpers and all showmanship classes, chains may be a part of the lead on the halter, but the chain portion cannot be placed in the horse's mouth or over the horse's nose

Tack and Equipment

A. Required

1. Halter with lead rope or shank
2. For driving see rules in the driving division
3. For showmanship please see rules in showmanship division
4. For costume class see class specifications in miscellaneous class section

B. Optional

1. Driving tack and equipment will be in line with the rules in the driving division
2. Any protective safety equipment for the rider (protective vest, other)

C. Allowed

1. Only equipment allowed in the show ring is allowed in the practice ring

General Specifications

1. Classes in this division are open to all equines 12 hands and under
2. Miniature horses to measure 39 inches and under
3. Outside assistance in any class after the judging has begun entails disqualification
4. Small Equine division participants are allowed to cross enter into the driving division classes (This rule is adjusted annually at Eastern States Exposition)
5. Driving classes for small equines will follow driving rules in this rulebook with reasonable adaptation for small equines, including splitting classes for safety. If classes are split it is the option of the show manager to award separate placing for the split classes

IN HAND OBSTACLES

- A. The obstacle course must be posted at the Show Office not less than one (1) hour prior to the class. Horses must be not less than (2) two years of age for In Hand Obstacles. The course designer may not exhibit in obstacle classes. All obstacles must be numbered on the course in order of sequence.
- B. In shows where open, amateur and youth obstacle classes are offered, at least three (3) of the obstacles must be different or the manner of performance through obstacles must be varied for the classes
- C. Obstacle Guidelines:
The course designer should be readily available to answer questions regarding the course and be available for a walkthrough the course with exhibitors as well as the judge(s). Judge shall walk the course with designer and exhibitors. Ingenuity and originality in adapting and combining various obstacles both to demonstrate a horse's willingness and ability to please exhibitors and audience are encouraged. However, unnatural or "horror" obstacles should be avoided and all obstacles should be safe for exhibitors as well as horses. Judge has the right to alter the course for time and/or safety.
- D. *An equine can only be shown by one exhibitor per class.*

Obstacle requirements:

1. Must be a minimum of five (5) obstacles and a maximum of eight (8); boundaries must be clearly marked for the course and be at least 4 feet from adjoining obstacles and the perimeter.
2. Care must be used to avoid setting any obstacle in a way that can be hazardous to the horse or exhibitor.
3. Tires and stair steps are prohibited.
4. Jumps, if used, should be between 4.5 feet and 6 feet wide with a maximum of twelve (12) inches high. Jumps must include ground poles.
5. All obstacles will be safe for both equine and youth

Suggested Obstacles

1. Back through or out of obstacle
2. Walk through water or simulated water
3. Put on and remove equipment (raincoat, saddle, etc.) from person or horse.
4. Walk through narrow passage
5. Pick up an object (letter, umbrella, bucket, flag, etc.) and place it at a designated location.
6. Walk across bridge or simulated bridge
7. Walk pattern created with poles, pylons, (figure 8, serpentine, cloverleaf, etc.)
8. Stand horse in circle, ground tie, walk around horse
9. Side-pass (either or both directions)

Judging and Scoring

Class to be judged 90% on the manner of the equine's performance through the course and 10% on responsiveness, willingness and general attitude

Baiting to encourage an animal to perform one of the obstacles is not allowed.

Any baiting is a disqualification

Maximum time 60 seconds per obstacle, if obstacle not completed in 60 seconds then whistle will sound and entry will move to next obstacle. Refusals of (3) three obstacles will constitute class disqualification

Off course is defined as:

1. Taking an obstacle in the wrong direction
2. Negotiating an obstacle from the wrong side
3. Skipping an obstacle unless directed by judge
4. Negotiating obstacles in the wrong sequence
5. Side pass the wrong end of horse in the obstacle
6. Small Equine leaving the obstacle course
7. Off course or out of bounds will result in elimination

Disqualifications: See # 14 under General Rules

IN HAND JUMPERS AND IN HAND HUNTERS

Personal attire and appointments

As listed above under Small Equine Division

Tack and Equipment

As listed above under Small Equine Division

General Rules for both

- A. All courses for Hunter and Jumper classes must be posted at least one (1) hour prior to the scheduled time of the class.
- B. Exhibitors **may not** go over jumps with horse
- C. Judge(s) and steward **shall** walk Hunter/Jumper course with designer and exhibitors prior to start of class
- D. Course diagrams must show with arrows the direction each obstacle must be taken.

- E. A start and finish line must be established at least twenty-four (24) feet from the first and last obstacle if possible, indicated by two (2) markers at least four (4) feet apart. Horses (exhibitors optional) must cross the line in the proper direction to start and complete the course.
- F. Horses must stay within the course boundaries as outlined by the start and finish cone. The start and/or finish cones outline the portion of the course in the immediate areas of the starting (first) and finishing (last) obstacles only, not the entire course.
- G. Baiting of horses to encourage an animal to perform any of the jumps is not allowed. **Any baiting is a disqualification.**
- H. Hunters and Jumpers may show with braided manes and tails in the manner of their larger counterparts
- I. This section is divided into two (2) types of classes – Jumpers and Hunters -horses are required to be a minimum of three (3) years of age to compete.

Jumps for In Hand Hunters and In Hand Jumpers

1. Jumps should be made of 1-1 1/2" schedule 40 PVC piping or other suitable lightweight material with jump cups and no protruding objects.
2. All jumps should be between 4 feet and 6 feet wide, with a minimum of eighteen (18) feet between jumps, with the exception of an in and out. In and outs should be set approximately ten (10) to twelve (12) feet apart and considered one jump and to be scored as such
3. Jumps shall not exceed thirty (30) inches in height
4. All post and rail jumps must have a ground pole
5. Standard to be a minimum of 4 inches above top rail or a maximum of forty (40) inches in height
6. Any decorations or jump wings must not protrude more than twenty-four (24) inches from the uprights

IN HAND JUMPERS

1. Minimum height for jumps must be twelve (12) inches and maximum height twenty-eight (28) inches (maximum height in jump offs may be up to 30 inches)
2. Whips are **not** permitted **in show ring**. Exhibitors' type of footwear is optional
3. Front leg wraps and/or boots are optional
4. Circling once upon entering the ring and once upon leaving the ring is permissible, but not after crossing starting line
5. Courses should be attractive, varied, and appropriate to their setting. Jumps could include brush, triple bar, water, and similar jumps. Brush jump must have a visible bar on top or beyond.
6. There will be a minimum of four (4) obstacles, with horses to jump a minimum of six (6) jumps and a maximum of eight (8) jumps.

Jump-Offs

1. Jump-offs are to occur for first place between the horses that tied for first place only.
2. The jump-offs will be held over the original course. The number and location of the jumps are to remain the same as well as the path of the course to be taken by the horse (pattern).
3. No jumps are to be eliminated or lowered.
4. Individual jumps will be increased not less than one inch and not more than six (6) inches in height for each jump-off. After the maximum height has been reached with all jumps in a jump-off, any required final tie breaking will be accomplished by continuing to rerun the last course set-up until ties are broken and the class is placed.
5. The horse with the fastest time and fewest faults will be declared the winner. A competitor who does not take part in the jump-off must always be placed behind a competitor who has been eliminated in that jump-off.

Judging and Scoring

Jumpers are scored mathematically, based on penalty faults including knockdowns, refusals and elimination incurred between the starting line and the finishing line

In scoring jumpers, an in and out is to be considered as two (2) jumps

Penalties and Faults

1. Knockdowns - **4 faults**

Knockdowns - An obstacle is considered knocked down when in jumping an obstacle, a horse or handler, by contact, lowers the established height of the fence in any way

2. Refusals - Each refusal - **3 faults**

A refusal is defined as stopping at an obstacle whether or not it is knocked down. It is penalized as a refusal. Stopping at an obstacle without knocking it down and without backing (even a single step), followed by jumping from a standstill is not penalized. However, if the halt continues or if the horse backs even a single step, side steps, or circles to retake the fence, a refusal is incurred. A run-out or refusal the horse must re-jump that obstacle at which the refusal occurred or be eliminated.

3. Circling after crossing starting line - **3 faults**

Circling - Any form of circle or circles whereby the horse crosses its original track between two (2) consecutive obstacles or stops advancing toward or turns away from the next fence except to retake an obstacle after a disobedience.

4. Crossing your own path (as in circling between fences, not as in retaking a fence from a refusal) – **3 faults**

A horse that has been penalized for circling cannot then be penalized again for crossing its own path at the same obstacle.

5. Causes for elimination:

- a. 3 refusals
- b. Off course
- c. Fall of horse and/or exhibitor
- d. Jumping of obstacle by exhibitor

- e. Failure to pass through the start and/or finish cones and/or knocking such cones over.
- f. Loss of control—dropping lead, horse running away, horse exiting on its own
- g. Disqualifications: See # 14 under General Rules

IN HAND HUNTERS

1. The course design for hunters should follow the same requirements as the course for jumpers
2. Fences – same size and height requirements as for Jumpers
3. Fences should simulate those found in hunting, such as natural post and rail, brush, stone wall, whiteboard gate, hedge, oxer, etc.
4. Circling once upon entering the ring and once upon leaving the ring is permissible
5. Upon completion of the entire class over jumps finalists will be trotted past the judge(s) for soundness check
6. Equines shall not be required to re-jump the course

Judging and Scoring

Hunters are to be judged on style, manners and way of going, with preference given to those equines that cover the course at an even pace, with free-flowing strides, as in a brisk trot or canter, but must maintain same gait throughout the entire course.

Causes for elimination in Hunter classes:

1. Three (3) refusals
2. Off course
3. Crossing your own path (as in circling between fences, not as in retaking a fence from a refusal or when following a course design)
4. Fall of equine or exhibitor
5. Jumping of obstacle by exhibitor
6. Carrying a whip
7. An unsound equine

Major faults to be scored:

1. Knockdowns
2. Touches
3. Refusals
4. Bucking or kicking
5. Spooking or shying
6. Wringing of tail
7. Showing an obstacle to equines
8. Not maintaining an even pace

Disqualifications: See # 14 under General Rules

IN HAND SUITABILITY

This class judges the communication between handler and equine.

Personal attire and appointments

As listed above under Small Equine Division

Tack and Equipment

As listed above under Small Equine Division

Gloves are not required for this class

Class Routine

Handlers will enter the ring at a walk while going the first way of the ring. Entries will be asked to follow given commands on the rail both ways of the ring that may include walking, trotting, stopping, backing and turning at any gait. Handlers and equine will also be asked to execute a pattern. Patterns may include any of the above gaits as well as ground tying.

Judging/Scoring

Equines and handlers will be judged:

70% on suitability as a team in communication and execution of rail work

15% on pattern completion

15% on presentation of both handler and equine

Disqualifications: See # 14 under General Rules

IN HAND COMMAND

This is an elimination contest where any handler not executing the judge's exact commands promptly and correctly will be eliminated

Personal attire and appointments

As listed above under Small Equine Division

Tack and Equipment

As listed above under Small Equine Division

Class Routine

Each command will be given twice. By the time the second command is given, (specifically when the announcer or judge has stopped speaking) the horse must be performing that command. When at the halt, movement forward, backward or to the side will result in elimination. Head movement of the horse or rider will not count against the entry.

Judges are encouraged to be the announcer for this class.

Judging/Scoring

Awarding of ribbons is to be based on the order of elimination of final contestants.

This is an elimination class.

Horses are excused as they fail to follow commands as directed above.

Disqualifications: See # 14 under General Rules

IN HAND ALL AROUND

The purpose of this class is to show the versatility of the 4-H horse that is being shown or handled in hand. This is **NOT** strictly a suitability, obstacle or halter class but a combination that will showcase the small equine and their versatility for all. This class is **Small Equine** specific. No registration papers are required for this class.

Judged 40% for suitability with the handler, 40% for obstacle or trail work and 20% on halter conformation.

Tack/Equipment/ Attire

All tack shall be clean, and in serviceable condition. Halter should fit the horse correctly. Tack used shall comply with the rules in the Small Equine division. Attire shall be as set forth in the Small Equine division.

Class Routine

A true family 4-H horse is easy to handle, quiet, usually easy gaited and does not show undesirable mannerisms. His overall performance should be smooth, consistent and obedient.

1. All horses enter the ring in a counterclockwise direction. All horses will be asked to walk, trot, and halt. Horses will be asked to back.
2. The first way of the ring, suitability will be the focus. The scoring will be evaluated on the horse's response to the handler including the handler's ability to maintain maximum performance. This will show the willingness of the horse to work with the handler to obtain peak performance.
3. The second way of the ring, obstacles will be the focus. The scoring will be evaluated on the horse's suitability to maneuver and complete 3 obstacles.
4. Once horses have gone both ways of the ring, they will be asked to come to the center, they will then be lined up head to tail for confirmation review.

Judging/Scoring

Suitability: To be judged 40% on this portion.

Obstacles: To be judged 40% on this portion.

Halter: A halter class is defined as a class where the horse is judged based upon its conformation. Selection should be of individuals in the order of their resemblance to the breed ideal represented and that are the most positive combination of balance, structural correctness, and movement with appropriate breed and sex characteristics and adequate muscling. Additionally, the horse and handler pair should be cooperatively working together to best show the horse's desirable halter characteristics. The condition of the horse also is considered. At the discretion of the judge, a horse may be penalized or eliminated from the class "if the horse appears sullen, dull, lethargic, emaciated, drawn or overly tired." **To be judged 20% on this portion.**

Disqualifications: See # 14 under General Rules

LIBERTY

General: Liberty is demonstrating the natural beauty of the pony/horse. Ponies/Horses are to be judged on style, grace, animation, gaits, presence, and ease of catching. The liberty animal is expected to perform at both a walk trot and canter. Use of the entire ring is expected. Ponies/Horses will be judged beginning when the halter is removed by the exhibitor (the individual wearing the number) and until caught and haltered by the exhibitor.

Time of liberty shall be 1½ minutes; time to catch shall be 1 ½ minutes.

GYMKHANA DIVISION

*You may need to check your state liability rules regarding ring size before adding any Gymkhana classes. **Safety is of major importance.***

Appointments

Tack, appointments, equipment as listed under appropriate division for seat ridden.

Optional

1. *Bat or crop not exceeding 24"; crops must have flat "popper"*
2. *Slip guards or kneepads*
3. *Body protection vest*
4. *Blunt spurs (not to be used forward of the cinch)*
5. *Non-standard equipment may be disqualified at the discretion of the judge*

Judging/Scoring

Scoring is determined by time.

Disqualifications

Any rider may be disqualified for any of the following reasons:

1. *Failure to enter or leave the arena under control and without assistance.*
2. *Failure to begin the course within one minute of entering the ring.*
3. *Off course. This includes negotiation of obstacles in other than the specified order or in the wrong direction.*
4. *Touching an obstacle with the rider's hand, whether or not the obstacle is knocked down as a result of touching it.*
5. *Soundness of each horse is at the discretion of the judge. Obvious lameness shall be cause for disqualification. Obvious lameness is consistently observably at a trot under all circumstances; marked nodding; hitching or shortened stride; minimal weight bearing in motion and/or at rest; and inability to move.*
6. *Fall of the horse or rider.*
7. *Failure of exhibitor to wear correct number in a visible manner.*
8. *Abusive handling as determined by the judge. Abuse may include, but not limited to the following: excessive spurring, use of spurs in front of the girth, excessive use of bat or crop, hitting with the bridle reins, hitting the horse in any way in front of the girth, hitting with flag, etc.*
9. *Use of tack or equipment, which is prohibited; breakage of equipment, which prevents completion of class.*
10. *Lack of sufficient control of the horse by its rider. A rider that obviously has no control of their horse while doing the pattern and produces an unsafe ride.*
11. **Loss of helmet from exhibitor's person at any time while exhibitor is in the ring.**
12. **Disqualifications: See # 14 under General Rules**

Penalties

Obstacle knockdown, i.e. poles, barrels, etc., - 5 second penalty.

Class Routine

The gate must remain closed and the horse comes to a halt inside the ring before the gate is opened again. All further stipulations by the show committee.

Personnel

1. Two timers, if automatic timers are not used.
2. Designated or appointed supervisor to oversee individual class routines.

Equipment

1. Cones to designate start and finish line for timed events.
2. Automatic timers or a minimum of 2 stop watches.
3. Tape measure.
4. Other equipment as specified in class routines or safe and suitable substitutions.

A clearly marked visible starting line such as stakes, pylons, lime or cones must be provided. An electric timer or two stopwatches should be used. The time recorded by either method will be the official time. Time penalties will be added to official time to determine placing. Lowest time (including any penalties) wins. Timer failure will entitle a rider to a re-run and the time obtained will be used plus any penalties occurring in the re-run. Circling once before leaving the ring is permissible.

Two hands are permitted on the reins. A rider may hold onto the saddle at any time during the run. Knocking over obstacles is a five second penalty per obstacle knocked over. A rider may bump an obstacle without penalty if it does not fall over. However, touching an obstacle with your hand to hold it up or trying to reset it is a disqualification. An obstacle is considered knocked over if it rolls on its side or flips end-over-end even if it lands in the upright position.

The show committee/management shall designate the order in which the entries shall compete. Cruelty to or the abuse of an animal, including excessive use of a whip or other implement, by any person at a 4-H event will result in immediate dismissal from the grounds. All class fees will be forfeited.

CLOVERLEAF BARREL RACE

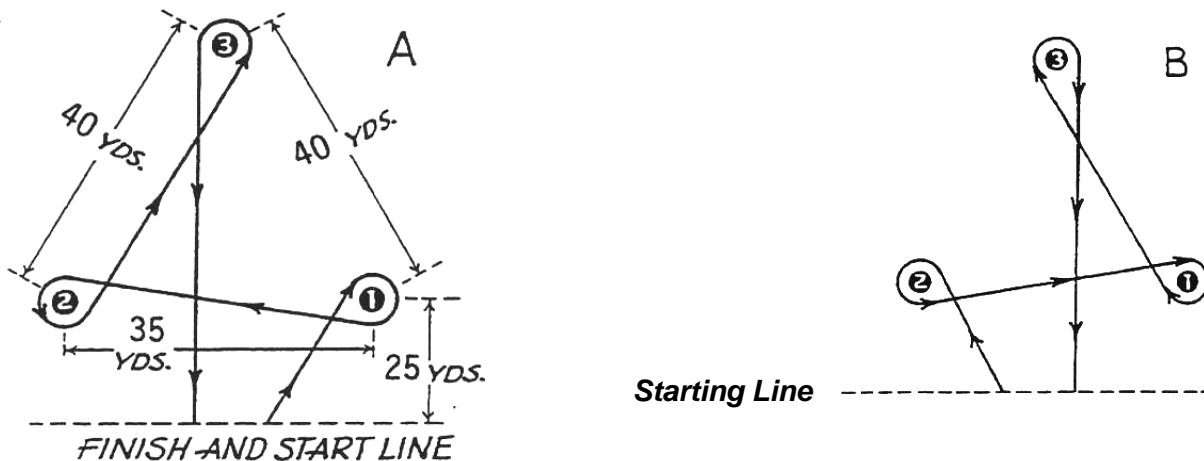

The contestant is allowed a running start and a choice of two methods of running the course. In the first method, at the signal from the starter, the entry will circle barrel number 1 clockwise, circle barrel number 2 counter-clockwise, circle barrel number 3 counterclockwise and then cross the finish line.

The course must be measured exactly. Barrels number 1 and 2 should be 25 yards from the timing line with a distance of 35 yards separating them. Barrel number 3 should be 40 yards from barrels 1 and 2. If the course is too long for the available space, the pattern should be reduced to 5 yards at a time until the pattern fits the arena. Adequate space should be allowed between the barrels and any

obstacle. The distance from barrel number 3 to the finish line need not be reduced 5 yards at a time if there is sufficient room for the horse to stop. Barrels should be set at least 15-20 feet from the arena walls or fences so the horses must turn around barrels, not at the fence. You may need to check your state liability rules regarding ring size before adding any Gymkhana classes.

FLAG RACE

Timed Event A pail of sand with a flag in it will be placed at far end of ring. Contestant is given another flag. Contestant rides around pail, places flag in pail and picks up other flag and races back to finish line. Flag must be in pail when contestant crosses finish line or contestant will be disqualified. Hitting horse with the flag will mean disqualification. Must cross finish line with the second flag. Flags should be two different colors. Variations of this race are available in different states.

KEYHOLE RACE

The starting line will be 50-100 feet (according to arena size) from the entrance to the keyhole. The entrance will be 4 feet wide and 10 feet long, connected to a circle 20 feet in diameter, forming a keyhole.

The contestants will cross the starting line, proceed through the entrance, turn right or left in the circle making a complete 180 degree turn.

The contestant will then return through the entrance and cross the finish line.

In addition to the disqualifications listed under general rules for game classes, a contestant may also be disqualified if the horse steps on or outside of the chalk line marking the entrance and circle of the course.

Keyhole Race

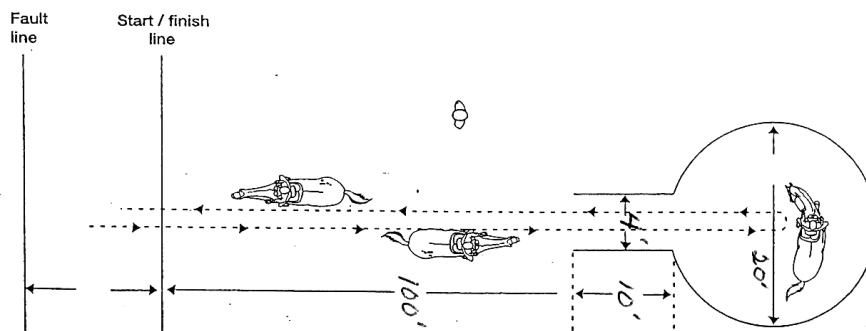

Arizona Keyhole Race

The chute may be created with ground poles and/or stakes. The rider will run into the chute and turn right or left around the stake or barrel and return back through the chute. The rider will be disqualified if the horse knocks down the chute or the stake/barrel. Chute to be 6' wide and 10' from turnaround stake or barrel.

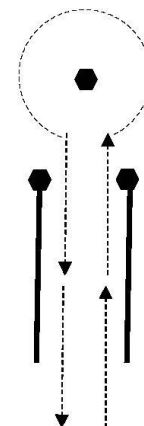

POLE BENDING

Poles (stakes) shall be approximately 1 ½" in diameter of a safe material that will not splinter. Each shall be from 6' – 7' high with a safe stable stand not more than 14 inches in diameter. Distances between poles and starting line to first pole should be 21' but may be reduced to 18' for pony competitors in a pony pole bending class. **For in-hand pole bending, both handler and animal must weave the pattern together.**

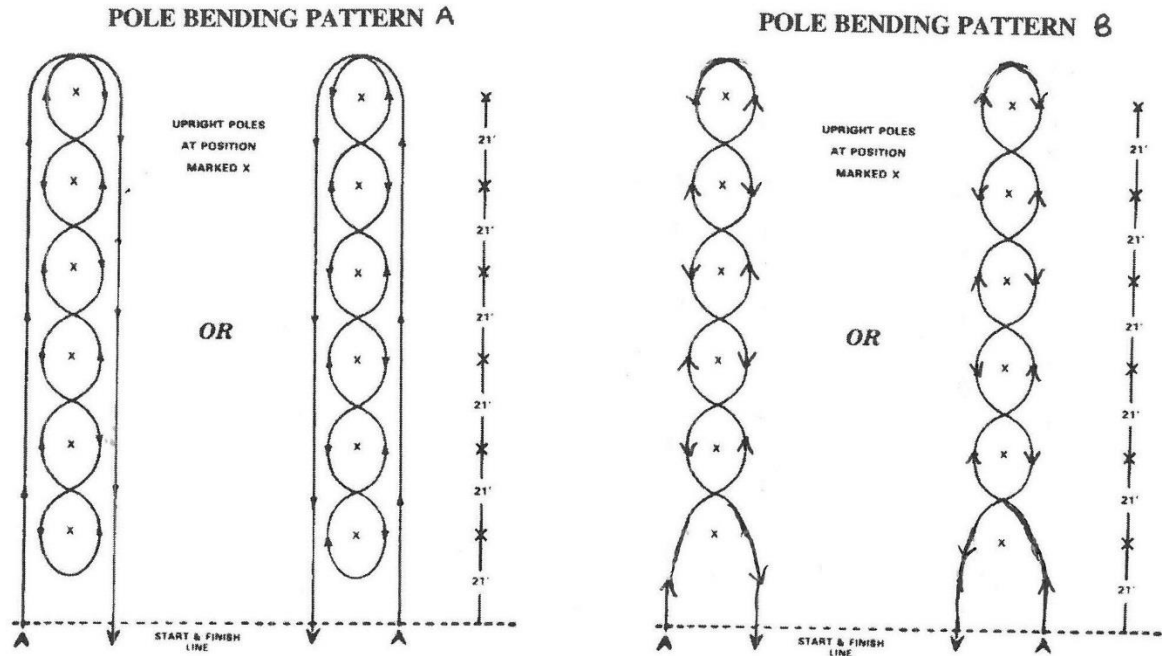

SIT-A-BUCK

Class Routine

Each exhibitor must ride bareback without a training saddle, blanket, etc. Upon entering the ring, the judge places a piece of paper (approximately 3" x 5") under the rider's leg between the knee and buttocks. The horses are then worked at a walk, trot, and canter both directions of the ring. Any rider not performing the gaits asked by the judge in a reasonable amount of time is eliminated.

As exhibitors lose their paper, they are eliminated. The last to lose the paper is first; next to last, second, etc.

EGG AND SPOON RACE

Class Set Up

The exhibitors are each given 1 egg and 1 spoon (preferably hard boiled or wooden eggs will be used). **Regular silverware teaspoons should be used.** Plastic spoons and regular silverware shall not be mixed. After everyone has received an egg and spoon the riders must proceed at a walk around the ring. It is permissible to hold the egg in place with the thumb until everyone has entered the ring and the judge gives the word for the class to begin. The exhibitors must then hold the spoon by the handle at least 1 inch from the bowl and not touch the egg with the thumb or fingers. Touching of the egg with any part of the body after the class begins shall result in disqualification.

Class Routine

The exhibitors will be asked to walk, trot/jog and canter/lope their mounts. If any exhibitors have their eggs after working both directions in the ring, the judge may ask for more intricate maneuvers such as stopping, riding with the feet out of the stirrups, backing up, or reverse at the trot/jog. Leads not to count unless specified to count by the judge. Any exhibitor not riding at the gait requested by the judge will be eliminated. As exhibitors lose their eggs, they will be eliminated. The last to drop the egg is the first; next to last, second, etc.

WATER RACE

Class Set Up

Each exhibitor is given a paper cup filled with water. It is a good idea to use cups with some sort of design on them so the water can be measured easily. It is recommended to put the exhibitor's number on the cup.

Class Routine

The class is worked at a walk, trot, and canter for a set amount of time. Usually 3 to 5 minutes will be sufficient. Any exhibitor not riding at the gait requested by the judge will be eliminated. The riders with the most amount of water left in their cups at the end of the ride will be the winners. A variation of this class has the riders hold the cup on their open palm as they ride.

RIBBON RIDE

Class Set Up and Routine

Entries are made in pairs; a pair consists of 2 horses and 2 riders. The riders hold between them a piece of paper (approximately 3" x 10") and ride as directed. Letting go of the paper by either rider or tearing (completely in two) of the paper eliminates the pair. Not riding at the gait requested by the judge eliminates the pair. The last pair to let go or tear their paper is first.

IZZY DIZZY (see diagram this section)

Class set up: Four cones to designate dismount area, horse handler, spotter and a bat.

Class Routine

Rider and horse ride to dismount area, dismount, lead horse to horse handler, run to bat, spin around bat a designated number of times (suggested 5 times) with head firmly touching bat (base of bat must stay on ground). Removal of head from bat requires participant to resume with spin #1). Upon completion of spins, participant then must run and cross finish line on foot.

IZZY DIZZY

HOLDER



**STOP AND DISMOUNT
BETWEEN CONES**

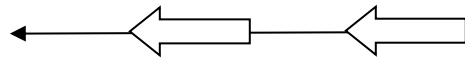
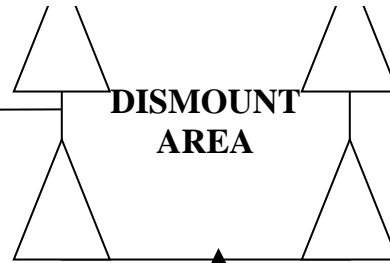

**LEAD HORSE
TO HOLDER**

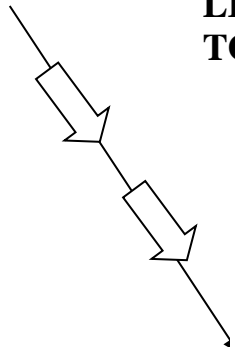

BAT

**SPIN AROUND BAT
HANDLE OF BAT
MUST BE AGAINST
THE FOREHEAD;
END OF BAT MUST
BE ON THE
GROUND**

SPOTTER



**RIDE
HORSE TO
DISMOUNT
AREA**

**RUN TO
FINISH LINE**



FINIS

STAR

DISQUALIFICATION

Stopping and/or dismounting anywhere other than between the dismount area cones. If the competitor over-runs the dismount area, he/she must return to the dismount area, stop and dismount.